

# Panasonic®

## User Guide

SIP Cordless Phone

Model No. **KX-TGP500** **B04**

Model No. **KX-TGP550** **T04**

DECT  
**6.0**

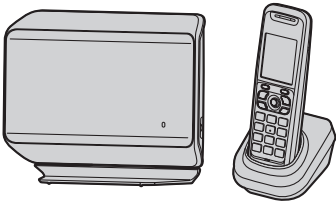

Model shown is KX-TGP500.

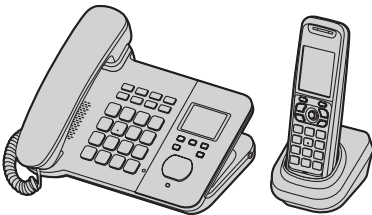

Model shown is KX-TGP550.

**Thank you for purchasing a Panasonic product.**

You can configure some of the features of this unit through the Web user interface. See “Programming through the Web user interface”, page 40.

Please read this guide before using the unit and save it for future reference.

## Table of Contents

### Introduction

|                                    |   |
|------------------------------------|---|
| About this guide                   | 4 |
| Model composition                  | 4 |
| About the Web user interface       | 4 |
| Emergency calls                    | 5 |
| Additional/replacement accessories | 5 |
| Expanding your phone system        | 5 |

### Getting Started

|   |    |
|---|----|
| Controls (Handset)                            | 6  |
| Controls (Base unit)                          | 6  |
| Understanding the indicators on the base unit | 8  |
| Display                                       | 9  |
| Initial settings                              | 10 |

### Making and Answering Calls using the Handset

|   |    |
|---|----|
| Making calls  | 12 |
| Using the speakerphone                              | 12 |
| Adjusting the receiver or speaker volume            | 12 |
| Making a call using the redial list                 | 12 |
| Editing/erasing/storing a number in the redial list | 12 |
| Answering calls                                     | 13 |
| Auto talk   | 13 |
| Adjusting the handset ringer volume                 | 13 |
| Temporary handset ringer off                        | 13 |
| Hold  | 13 |
| Making another call during a call                   | 13 |
| Useful features during a call                       | 13 |
| Transferring calls to an outside party              | 14 |
| Conference calls                                    | 15 |

### Making and Answering Calls using the Base Unit (KX-TGP550 only)

|   |    |
|---|----|
| Making calls  | 16 |
| Using the speakerphone                              | 16 |
| Off-hook monitor                                    | 16 |
| Adjusting the receiver or speaker volume            | 16 |
| Making a call using the redial list                 | 16 |
| Editing/erasing/storing a number in the redial list | 17 |
| Answering calls                                     | 17 |
| Adjusting the base unit ringer volume               | 17 |
| Temporary base unit ringer off                      | 17 |
| Hold  | 17 |
| Making another call during a call                   | 17 |
| Useful features during a call                       | 18 |
| Transferring calls to an outside party              | 18 |
| Conference calls                                    | 19 |

### Phonebook using the Handset

|                                       |    |
|---------------------------------------|----|
| Using the phonebook                   | 20 |
| Adding entries                        | 20 |
| Finding and calling a phonebook entry | 20 |
| Editing entries                       | 21 |
| Erasing entries                       | 21 |
| Chain dial                            | 21 |
| Speed dial                            | 21 |
| Export/import phonebook entries       | 22 |

### Phonebook using the Base Unit (KX-TGP550 only)

|                                       |    |
|---------------------------------------|----|
| Using the phonebook                   | 23 |
| Adding entries                        | 23 |
| Finding and calling a phonebook entry | 23 |
| Editing entries                       | 24 |
| Erasing entries                       | 24 |
| Chain dial                            | 24 |
| Speed dial                            | 24 |
| Copying base unit phonebook entries   | 25 |
| Export/import phonebook entries       | 25 |

### Programming using the Handset

|   |    |
|---|----|
| Programmable settings                     | 26 |
| Call forward                              | 29 |
| Do not disturb                            | 30 |
| Block anonymous calls                     | 30 |
| Call block (Caller ID service users only) | 30 |
| Anonymous calls (Block Caller ID)         | 31 |
| Changing the handset name                 | 31 |
| Date and time                             | 31 |
| Updating the base unit software           | 32 |

### Programming using the Base Unit (KX-TGP550 only)

|   |    |
|---|----|
| Programmable settings                     | 33 |
| Call forward                              | 36 |
| Do not disturb                            | 37 |
| Block anonymous calls                     | 37 |
| Call block (Caller ID service users only) | 37 |
| Anonymous calls (Block Caller ID)         | 38 |
| Date and time                             | 38 |
| Updating the base unit software           | 38 |

### Programming through the Web User Interface

|  |    |
|--|----|
| Programming through the Web user interface | 40 |
|--|----|

### Registering a Unit

|                    |    |
|--------------------|----|
| Registering a unit | 41 |
|--------------------|----|

### Special Features

|                         |    |
|-------------------------|----|
| Using Caller ID service | 42 |
|-------------------------|----|

|  |    |
|--|----|
| Caller list . . . . .  | 42 |
| Voice mail service . . . . .   | 44 |
| <b>Intercom Features</b>   |    |
| Intercom features between handsets . . . . .                                   | 45 |
| Intercom features between the handset and base unit (KX-TGP550 only) . . . . . | 46 |
| Handset locator . . . . .  | 47 |
| <b>Useful Information</b>  |    |
| Belt clip . . . . .  | 48 |
| Wall mounting . . . . .  | 48 |
| Error messages . . . . .   | 50 |
| Troubleshooting . . . . .  | 51 |
| Specifications . . . . .   | 56 |
| <b>Open Source Software</b>  |    |
| Open Source Software . . . . .   | 57 |
| <b>Index</b>   |    |
| Index . . . . .  | 63 |

### About this guide

This guide explains how to operate and customize KX-TGP500/KX-TGP550. Please be sure your network is configured for KX-TGP500/KX-TGP550. Contact your administrator about the network settings and available features.

### Model composition

#### ■ KX-TGP500 series

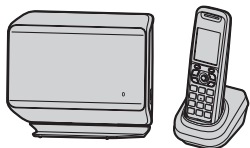

#### ■ KX-TGP550 series

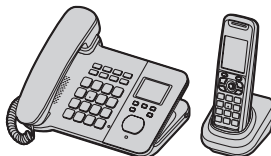

| Series           | Model No. | Base unit | Handset  |          |
|------------------|-----------|-----------|----------|----------|
|                  |           | Part No.  | Part No. | Quantity |
| KX-TGP500 series | KX-TGP500 | KX-TGP500 | KX-TPA50 | 1        |
| KX-TGP550 series | KX-TGP550 | KX-TGP550 | KX-TPA50 | 1        |

#### Feature differences

| Series           | Intercom                      |                  | Making or answering calls with base unit |
|------------------|-------------------------------|------------------|--|
|                  | Between base unit and handset | Between handsets |  |
| KX-TGP500 series | —                             | ●*1              | —  |
| KX-TGP550 series | ●                             | ●*1              | ●  |

\*1 Intercom calls can be made between the handsets by purchasing and registering one or more optional handsets (page 5).

### About the Web user interface

You can configure some of the features of this unit through the Web user interface (page 40). You can access this interface from a web browser on any computer connected to the network. Contact your administrator for further information.

## Emergency calls

All lines including unassigned lines are available for emergency calls if the phone numbers are configured in the Web user interface. Availability depends on your phone system. Contact your administrator for further information.

## Additional/replacement accessories

Please contact your nearest Panasonic dealer for sales information.

| Accessory item         | Order number   |
|------------------------|--|
| Rechargeable batteries | HHR-4DPA* <sup>1</sup> <ul style="list-style-type: none"> <li>To order, please call 1-800-332-5368 or visit <a href="http://www.panasonic.com/batterystore">http://www.panasonic.com/batterystore</a></li> </ul> |
|                        | Battery type: <ul style="list-style-type: none"> <li>Nickel metal hydride (Ni-MH)</li> <li>2 x AAA (R03) size for each handset</li> </ul>  |
| Headset                | KX-TCA60, KX-TCA93, KX-TCA94   |

\*1 Replacement batteries may have a different capacity from that of the supplied batteries.

## Expanding your phone system

You can expand your phone system by registering optional handsets (6 max.) to a single base unit.

Handset (optional): KX-TPA50 **B04**



## Controls (Handset)

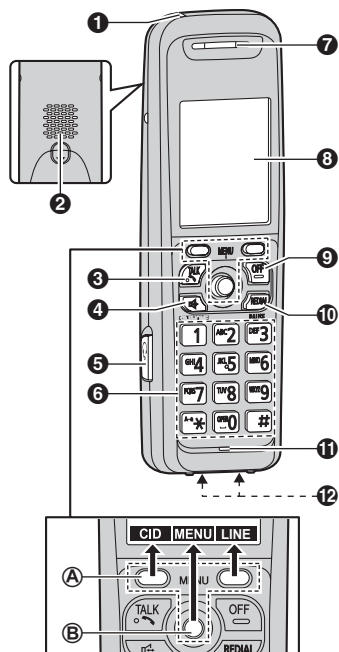

- ❶ Charge indicator  
Ringer indicator  
Message indicator
- ❷ Speaker
- ❸ [TALK]
- ❹ [SP-PHONE: Speakerphone]
- ❺ Headset jack
- ❻ Dial keypad
- ❼ Receiver
- ❽ Display
- ❾ [OFF]
- ❿ [REDIAL] [PAUSE]<sup>\*1</sup>
- ⓫ Microphone
- ⓬ Charge contacts

\*1 A 3.5 second pause is inserted each time [PAUSE] is pressed. It is useful when you want to operate voice mail service without listening to pre-recorded announcement, for example. Repeat as needed to create longer pauses.

## ■ Control type

### Ⓐ Soft keys

The handset features 2 soft keys and a joystick. By pressing a soft key, or by pressing the center of the joystick, you can select the feature shown directly above it on the display.

### Ⓑ Joystick

By pushing the joystick ([▲], [▼], [◀], or [▶]) repeatedly, you can:

- scroll through (up, down, left, or right) various lists or items
- adjust the receiver or speaker volume (up or down) while talking
- As all multiple items cannot be displayed on screen at the same time, you can quickly search for the desired item to move screens by pushing the joystick right or left, instead of scrolling down or up line by line (page 10).

## Controls (Base unit)

### KX-TGP500

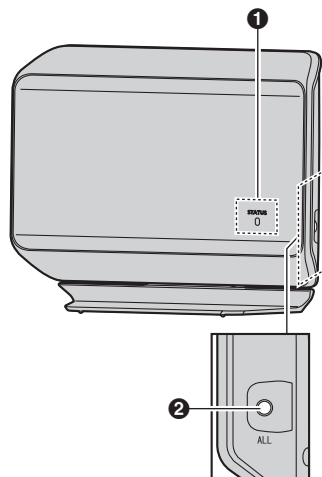

- ❶ STATUS indicator
- ❷ Handset locator button [ALL]

## KX-TGP550

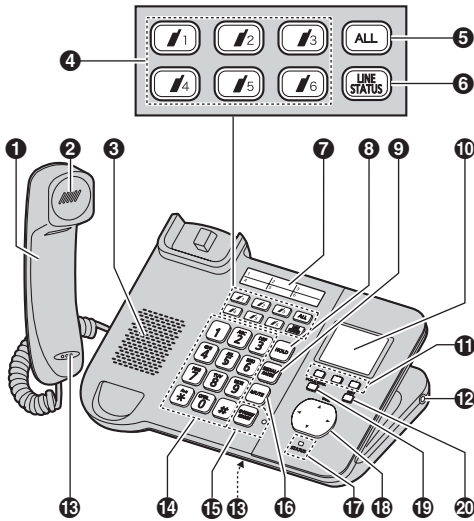

- 1 Corded handset
- 2 Receiver
- 3 Speaker
- 4 Handset paging buttons ([1] - [6])  
Handset status indicators
- 5 Handset paging button [ALL]
- 6 [LINE STATUS]
- 7 Index sticker
- 8 [HOLD]
- 9 [REDIAL] [PAUSE]\*1
- 10 Display
- 11 Soft keys
- 12 Headset jack
- 13 Microphone
- 14 Dial keypad
- 15 [SP-PHONE] [HEADSET]  
SP-PHONE indicator
- 16 [MUTE]
- 17 STATUS indicator
- 18 Navigator key ([▲]/[▼]/[◀]/[▶])  
VOL. (Volume: [▲]/[▼])
- 19 [VOICE MAIL]\*2  
VOICE MAIL indicator
- 20 [EXIT]

\*1 A 3.5 second pause is inserted each time [PAUSE] is pressed. It is useful when you want to operate voice mail service without listening to

pre-recorded announcement, for example. Repeat as needed to create longer pauses.  
\*2 Your phone system needs to support voice mail. Contact your administrator for further information.

## Navigator key/volume key

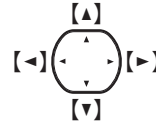

- Scrolling through lists or items

By pressing this key ([▲], [▼], [◀], or [▶]) repeatedly, you can scroll through (up, down, left, or right) various lists or items.

- Adjusting the volume

By pressing this key ([▲] or [▼]) repeatedly, you can adjust the receiver or speaker volume (up or down) while talking.

- Moving the cursor

By pressing this key ([▲], [▼], [◀], or [▶]) repeatedly, you can move the cursor to edit a number or name.

## Soft keys

The base unit features 3 soft keys. By pressing a soft key, you can select the feature shown directly above it on the display.

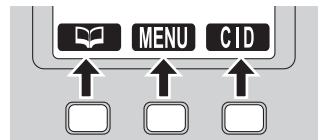

## Understanding the indicators on the base unit

### STATUS indicator

During the startup process you may notice that the STATUS indicator on the base unit is flashing. This indicates that the base unit is booting up with your phone system. You may find the following flash patterns helpful:

| Status |                  | Meaning   |
|--------|------------------|---|
| Color  | Light pattern    |   |
| Green  | On               | <ul style="list-style-type: none"> <li>The base unit is connected to the Internet. The startup process is complete and you may now make and receive internet calls.</li> </ul>  |
|        | Flashing         | <ul style="list-style-type: none"> <li>The base unit is downloading data. Do not disconnect the Ethernet cable or AC adaptor from the base unit until the STATUS indicator stops flashing and lights in steady green.</li> </ul>  |
| Red    | On               | <ul style="list-style-type: none"> <li>When the base unit is turned on, the STATUS indicator lights in red for about 10 seconds.</li> </ul>   |
|        | Flashing         | <ul style="list-style-type: none"> <li>The base unit is registering a handset.</li> </ul>   |
|        | Flashing rapidly | <ul style="list-style-type: none"> <li>The base unit is paging handsets. (KX-TGP500 only)</li> </ul>  |
| Amber  | On               | <ul style="list-style-type: none"> <li>The base unit's IP address may conflict with the IP addresses of other devices on your local network. Contact your administrator for further information.</li> </ul>   |
|        | Flashing         | <ul style="list-style-type: none"> <li>The base unit is obtaining an IP address or is obtaining configurations. Please wait.</li> <li>The base unit is registering with your phone system. Please wait.</li> <li>If the STATUS indicator continues flashing, check the following:                             <ul style="list-style-type: none"> <li>Network settings may not be correct. Contact your administrator.</li> <li>Many installation issues can be resolved by resetting all the equipment. First, shut down your modem, router, hub, base unit, and computer. Then turn the devices back on one at a time in this order: modem, router, hub, base unit, computer.</li> <li>If you cannot access Internet Web pages using your computer, check to see if your phone system is having connection issues in your area.</li> <li>For more troubleshooting help, contact your administrator.</li> </ul> </li> </ul> |
|        | Flashing rapidly | <ul style="list-style-type: none"> <li>Unplug the base unit's AC adaptor to reset the unit, then reconnect the AC adaptor. If the STATUS indicator is still flashing rapidly, there may be a problem with the base unit hardware. Contact your phone system dealer.</li> </ul>  |
| Off    | —                | <ul style="list-style-type: none"> <li>The base unit power is off.</li> <li>The Ethernet cable is not connected properly. Connect it.</li> <li>Your network devices (hub, router, etc.) are turned off. Check the LEDs for the link status of the devices.</li> <li>The base unit power is booting up.</li> </ul>   |



## Handset status indicators

**Available for:** KX-TGP550















The handset status indicators on the base unit show the status of each handset as follows:





| Status    | Meaning   |
|-----------|---|
| Light off | The handset is free.                                      |
| Light on  | The handset is in use.                                    |
| Flashing  | The handset is paging the base unit or being paged by it. |

## Display

### Handset display items







#### Display items

| Item   | Meaning   |
|--|---|
|    | Within range of the base unit   |
|    | Out of range of the base unit   |
|    | The line is available.  |
|    | The line is in use. <ul style="list-style-type: none"> <li>When flashing: The call is put on hold.</li> <li>When flashing rapidly: An incoming call is now being received.</li> </ul> |
|    | Speaker is on. (page 12)  |
|    | Ringer volume is off. (page 13)   |
|    | The line is set to allow other units to join the call. (page 12, 13)  |
|  | Handset number  |
|  | Battery level   |
|  | Blocked call (page 30)  |
|  | Block anonymous call (page 30)  |
|  | Call forward (page 29)  |
|  | Do not disturb (page 30)  |
|  | Anonymous calls (Block Caller ID) (page 31)   |
|  | The line has received new voice mail messages. (page 44)  |

| Item  | Meaning  |
|---|--|
|  | Handset 1 is in use.<br>“4”–“6”: Handset<br>“0”: Base unit (KX-TGP550 only)  |
|  | The shared line is in use. (page 14)   |
|  | The line is now registering the VoIP server.   |
|  | Line number (8 max.) <ul style="list-style-type: none"> <li>When receiving a call, the last 4 digits are displayed.</li> </ul> |

### Main menu icons







The following icons are shown when you press down on the center of the joystick in standby mode.







| Icon  | Feature          |
|---|------------------|
|  | Line status      |
|  | IP service       |
|  | New Voice Mail   |
|  | Intercom         |
|  | Initial settings |
|  | Phonebook        |

### Base unit display items

**Available for:** KX-TGP550







#### Display items

| Item  | Meaning   |
|---|---|
|  | The line is available.  |
|  | The line is in use. <ul style="list-style-type: none"> <li>When flashing: The call is put on hold.</li> <li>When flashing rapidly: An incoming call is now being received.</li> </ul> |
|  | Ringer volume is off. (page 17)   |
|  | The line is set to allow other units to join the call. (page 16, 17)  |
|  | Blocked call (page 37)  |
|  | Block anonymous call (page 37)  |
|  | Call forward (page 36)  |

| Item   | Meaning   |
|--|---|
|  | Do not disturb (page 37)  |
|  | Anonymous calls (Block Caller ID) (page 38)   |
|  | The line has received new voice mail messages. (page 44)  |
|  | Handset 1 is in use.<br>“1”–“6”: Handset  |
|  | The shared line is in use. (page 18)  |
|  | The line is now registering the VoIP server.  |
|  | Line number (8 max.)<br><ul style="list-style-type: none"> <li>When receiving a call, the last 4 digits are displayed.</li> </ul> |

### Main menu icons

The following icons are shown when you press **[MENU]** (middle soft key) in standby mode.

| Icon   | Feature          |
|--|------------------|
|  | Line status      |
|  | IP service       |
|  | Ringer settings  |
|  | Initial settings |
|  | Phonebook        |
|  | Caller list      |

### Temporarily switching the handset display mode

You can select to display either a single item or multiple items on one screen at a time for the phonebook list, caller list, and redial list.

You can temporarily switch the handset display mode as follows by pressing the right soft key shown when viewing the lists with:

- **[MULTI]**: Multiple items are shown on one screen at a time.
- **[SINGLE]**: An item is shown on one screen at a time. You can confirm the detailed information.



#### Note:

- When in multiple display mode, you can move screens by pushing the joystick right or left, without scrolling down or up through the list:
  - Push the joystick right to go to the next screen.

- Push the joystick left to return to the previous screen.

## Initial settings

### Symbol meaning:

| Symbol  | Meaning  |
|---|--|
|  | Perform with the handset.  |
|  | Perform with the base unit.  |
| <b>Example:</b><br><b>[▼]/[▲]: “Off”</b>  | <b>Handset:</b> Push the joystick down or up to select the words in quotations.<br><b>Base unit (KX-TGP550):</b> Press <b>[▼]</b> or <b>[▲]</b> to select the words in quotations. |

### Display language

You can select either “English” or “Español” as the display language. The default setting is “English”.

#### Handset

- 1 **[MENU]** (center of joystick) → **[#][1][1][0]**
- 2 **[▼]/[▲]**: Select your desired setting.
- 3 Press down the center of the joystick to save. → **[OFF]**

#### Base unit

**Available for:** KX-TGP550

- 1 **[MENU]** (middle soft key) → **[#][1][1][0]**
- 2 **[▼]/[▲]**: Select your desired setting.
- 3 Press the middle soft key to save. → **[EXIT]**

### Confirming your phone number(s)

You may have more than one phone number, depending on your phone system. The numbers can be shared with multiple units (page 14, 18). Contact your administrator for further information.

### Confirming the line status of VoIP server

The unit shows all available phone numbers in your phone system and their current status. You can select a line to make a call.

 **Handset**

- 1 **[LINE]** (right soft key)
- 2 **[▼]/[▲]**: Select the desired line.
  - The display shows the current status of the line. See page 9 for details.
  - To select the line to make a call, press **[↶]**.
- 3 **[OFF]**

 **Base unit**

**Available for:** KX-TGP550

- 1 **[LINE STATUS]**
- 2 **[▼]/[▲]**: Select the desired line.
  - The display shows the current status of the line. See page 9 for details.
  - To select the line to make a call, lift the corded handset.
- 3 **[EXIT]**

## Making calls

- 1 Lift the handset and dial the phone number.
  - To correct a digit, press **[CLEAR]**.
- 2 Press **[CALL]** or **[↶]**.
  - The unit selects the default line configured by your administrator.
  - You can also select the line manually as follows:  
**[LINE]** → **[▼]/[▲]**: Select the desired line.  
→ **[CALL]**
- 3 When you finish talking, press **[OFF]** or place the handset on the charger.

### Note:

- If ↓ is displayed during the call, other units may join the conversation (page 14, 18). Contact your administrator for further information.
- A maximum of 3 lines can be used at a time.
- To use the optional headset, plug the headset into the headset jack before performing step 1.

## Using the speakerphone

- 1 Dial the phone number and press **[☎]**.
  - The unit selects the default line configured by your administrator.
  - You can also select the line manually as follows:  
**[LINE]** → **[▼]/[▲]**: Select the desired line.  
→ **[☎]**
  - Speak alternately with the other party.
- 2 When you finish talking, press **[OFF]**.

### Note:

- For best performance, use the speakerphone in a quiet environment.
- To switch back to the receiver, press **[↶]**.

## Adjusting the receiver or speaker volume

Push the joystick up or down repeatedly while talking.

## Making a call using the redial list

The last 10 phone numbers dialed are stored in the redial list (each 32 digits max.).

- 1 **[REDIAL]**
- 2 **[▼]/[▲]**: Select the desired phone number.
- 3 **[↶]/[☎]**
  - If **[☎]** is pressed and the other party's line is engaged, the unit automatically redials multiple times. While the handset is waiting to redial, the ringer indicator flashes. To cancel, press **[OFF]**.

## Editing/erasing/storing a number in the redial list

- 1 **[REDIAL]**
- 2 **[▼]/[▲]**: Select the desired phone number. → **[MENU]**
- 3 Proceed with the desired operation.
  - **Editing a number before calling:**  
**[▼]/[▲]**: "Edit and Call" → **[SELECT]** → Use the joystick to move the cursor. → Edit the number. → Press **[CALL]** or **[↶]**.
  - **Erasing a number:**  
**[▼]/[▲]**: "Erase" → **[SELECT]** → **[▼]/[▲]**: "Yes" → **[SELECT]** → **[OFF]**
  - **Storing a number to the phonebook:**  
**[▼]/[▲]**: "Save phonebook" → **[SELECT]** → To store the name, continue from step 3, "Editing entries", page 21.

### Note:

- When editing:
  - To erase a number, place the cursor on the number, then press **[CLEAR]**.
  - To insert a number, place the cursor to the right of where you want to insert the number, then press the appropriate dial key.

---

## Answering calls

When a call is being received, the ringer indicator on the handset flashes rapidly. The last 4 digits of the line number on which the call is being received are displayed.

- 1 Lift the handset and press **[CALL]**, **[↶]**, or **[↷]** when the unit rings.
  - You can also answer the call by pressing any dial key from **[0]** to **[9]**, **[\*]**, or **[#]**.  
**(Any key answer feature)**
- 2 When you finish talking, press **[OFF]** or place the handset on the charger.

### Note:

- If the auto talk feature is turned off (page 13), you can select which line answers when more than one call is being received:  
**[CALL]** → **[▼]/[▲]**: Select the desired line.  
→ Press **[CALL]**, **[↶]**, or **[↷]**.
- If **↓** is displayed during the call, other units may join the conversation (page 14, 18). Contact your administrator for further information.

---

## Auto talk

You can answer calls simply by lifting the handset off the charger. You do not need to press **[CALL]** or **[↶]**. To turn this feature on, see page 27.

---

## Adjusting the handset ringer volume

### ■ While the handset is ringing for an incoming call:

Push the joystick up or down repeatedly to select the desired volume.

### ■ Programming the volume beforehand:

- 1 **[MENU]** (center of joystick) → **[#][1][6][0]**
- 2 **[▼]/[▲]**: Select the desired volume.
- 3 **[SAVE]** → **[OFF]**

---

## Temporary handset ringer off

While the handset is ringing for a call, you can turn the ringer off temporarily by pressing **[⏏]**.

---

## Hold

This feature allows you to put an outside call on hold.

- 1 Press **[HOLD]** during an outside call.
- 2 To release hold, press **[HOLD]** or **[↶]**.

### Note:

- If a call is kept on hold for more than 9 minutes, an alarm tone starts to sound and the ringer indicator on the handset flashes. If the outside party hangs up the call, the unit disconnects the line and goes into standby mode.

---

## Making another call during a call

You can make a call using the other line by holding the 1st call.

- 1 Press **[HOLD]** to put the 1st call on hold.
- 2 Dial the phone number. → **[CALL]**
- 3 To return to the 1st call, press **[SWITCH]**.

---

## Useful features during a call

### Mute

While mute is turned on, you can hear the other party, but the other party cannot hear you.

- 1 Press **[MUTE]** during an outside call.
- 2 To return to the conversation, press **[MUTE]** again.

### Note:

- **[MUTE]** is a soft key visible on the display during a call.

### Call waiting

This feature allows you to receive calls while you are already talking on the phone. If you receive a call while on the phone, the 2nd caller's information is displayed on the handset that is in use after you hear the interrupt tone (page 28). The feature depends on your phone system. Contact your administrator for further information.

- 1 Press **[SWITCH]** to answer the 2nd call.
- 2 To switch between calls, press **[SWITCH]**.

### Call share

#### Joining a call

You can join an existing outside call. Availability depends on your phone system. Contact your administrator for further information.

#### Important:

- The line must be set to allow other units to join through the Web user interface ("Privacy Mode").  is displayed on the unit currently in use when it is allowed to join the call. Contact your administrator for further information.
- 1 Press **[LINE]** when the other unit is on an outside call.
  - 2 **[▼]/[▲]**: Select the desired line to join. → **[SELECT]**

#### Sharing line numbers among multiple base units

If you have multiple base units, shared line number(s) may be assigned to selected units by your administrator. While the shared line is being used by other units,  is displayed when viewing the line status (page 10). Availability depends on your phone system. Contact your administrator for further information.

#### Note:

- This feature is explained as "Enable Shared Call" in the Web user interface.

### Transferring calls to an outside party

Outside calls can be transferred to an outside party. To transfer outside calls to another unit, see "Transferring calls", page 45, 47.

- 1 During an outside call, press **[MENU]**.
- 2 **[▼]/[▲]**: "Transfer" → **[SELECT]**
- 3 Dial the phone number.
  - To correct the number, press **[CANCEL]** to clear the number and enter again.
- 4 Wait for the paged party to answer.
  - If the paged party does not answer, press **[CANCEL]** 2 times to return to the outside call.
- 5 **[TRANS]**

#### Note:

- In step 3, you can dial the phone number from the phonebook:  
**[📖]** → **[▼]/[▲]**: Select the desired entry. → **[CALL]**

### Transferring a call without speaking to the outside party

- 1 During an outside call, press **[MENU]**.
- 2 **[▼]/[▲]**: "Blind transfer" → **[SELECT]**
- 3 Dial the phone number.
  - To correct the number, press **[CANCEL]** to clear the number and enter again.
- 4 **[TRANS]**
  - The outside call rings at the other unit.

#### Note:

- In step 3, you can dial the phone number from the phonebook:  
**[📖]** → **[▼]/[▲]**: Select the desired entry. → **[CALL]**

---

---

## Conference calls

Multiple people can establish a conference call.

- 1 During an outside call, press **[MENU]**.
- 2 **[▼]/[▲]**: “Conference” → **[SELECT]**
- 3 Dial the phone number.
  - To correct the number, press **[CANCEL]** to clear the number and enter again.
- 4 Wait for the paged party to answer.
  - If the paged party does not answer, press **[CANCEL]** 2 times to return to the outside call.
- 5 **[CONF]**
  - If you want to add a new party to the conference, perform from step 1.

**Note:**

- In step 3, you can dial the phone number from the phonebook:  
**[📖]** → **[▼]/[▲]**: Select the desired entry. → **[CALL]**

### Making calls

- 1 Dial the phone number.
  - To correct a digit, press **[CLEAR]**.
- 2 Lift the corded handset.
  - The unit selects the default line configured by your administrator.
  - You can also select the line manually as follows:  
**[LINE]** → **[▼]/[▲]**: Select the desired line.  
→ Lift the corded handset.
- 3 When you finish talking, place the corded handset on the cradle.

#### Note:

- You can also dial the phone number after lifting the corded handset.
- If  $\downarrow$  is displayed during the call, other units may join the conversation (page 14, 18). Contact your administrator for further information.
- A maximum of 3 lines can be used at a time.

#### Using the headset (optional)

First, plug the headset into the headset jack. Then press **[SP-PHONE/HEADSET]** instead of using the corded handset in steps 2 and 3, "Making calls", page 16.

- To end the call, press **[SP-PHONE/HEADSET]**.
- **[SP-PHONE/HEADSET]** is stated as **[SP-PHONE]** in the following steps through this User Guide.

### Using the speakerphone

- 1 Dial the phone number and press **[SP-PHONE]**.
  - The unit selects the default line configured by your administrator.
  - You can also select the line manually as follows:  
**[LINE]** → **[▼]/[▲]**: Select the desired line.  
→ Press **[CALL]** or **[SP-PHONE]**.
- 2 When the other party answers, speak into the base unit microphone.
  - Speak alternately with the other party.
- 3 When you finish talking, press **[SP-PHONE]**.

#### Note:

- For best performance, use the speakerphone in a quiet environment.
- To switch to the receiver, lift the corded handset.

### Off-hook monitor

You can let other people in the room listen to a conversation through the speaker while continuing the conversation using the corded handset.

During a conversation with the corded handset, press **[SP-PHONE]**.

- While the feature is turned on, the SP-PHONE indicator on the base unit lights.
- To return to the private call, press **[SP-PHONE]**.

### Adjusting the receiver or speaker volume

Press **[▲]** or **[▼]** repeatedly while talking.

### Making a call using the redial list

The last 10 phone numbers dialed are stored in the redial list in each unit (each 32 digits max.).

- 1 **[REDIAL]**
- 2 **[▼]/[▲]**: Select the desired phone number.
- 3 Lift the corded handset or press **[SP-PHONE]**.
  - If **[SP-PHONE]** is pressed and the other party's line is engaged, the unit automatically redials multiple times. While the base unit is waiting to redial, the SP-PHONE indicator on the base unit flashes. To cancel, press **[EXIT]**.



## Editing/erasing/storing a number in the redial list

- 1 **[REDIAL]**
- 2 **[▼]/[▲]**: Select the desired phone number. → **[MENU]**
- 3 Proceed with the desired operation.
  - **Editing a number before calling:**  
**[▼]/[▲]**: “Edit and Call” → **[SELECT]**  
→ Press **[←]** or **[→]** to move the cursor.  
→ Edit the number. → Lift the corded handset.
  - **Erasing a number:**  
**[▼]/[▲]**: “Erase” → **[SELECT]** →  
**[▼]/[▲]**: “Yes” → **[SELECT]** → **[EXIT]**
  - **Storing a number to the phonebook:**  
**[▼]/[▲]**: “Save phonebook” →  
**[SELECT]** → To store the name, continue from step 3, “Editing entries”, page 24.

### Note:

- When editing:
  - To erase a number, place the cursor on the number, then press **[CLEAR]**.
  - To insert a number, place the cursor to the right of where you want to insert the number, then press the appropriate dial key.

## Answering calls

The last 4 digits of the line number on which the call is being received are displayed.

- 1 Lift the corded handset or press **[CALL]** or **[SP-PHONE]** when the unit rings.
- 2 When you finish talking, place the corded handset on the cradle. When the speakerphone is used, press **[SP-PHONE]**.

### Note:

- You can select which line answers when more than one call is being received:  
**[CALL]** → **[▼]/[▲]**: Select the desired line.  
→ Lift the corded handset or press **[CALL]** or **[SP-PHONE]**.
- If  $\downarrow$  is displayed during the call, other units may join the conversation (page 14, 18). Contact your administrator for further information.

## Adjusting the base unit ringer volume

- **While the base unit is ringing for an incoming call:**  
Press **[▲]** or **[▼]** repeatedly to select the desired volume.
- **Programming the volume beforehand:**
  - 1 **[MENU]** (middle soft key) → **[±][1][6][0]**
  - 2 **[▼]/[▲]**: Select the desired volume.
  - 3 **[SAVE]** → **[EXIT]**

## Temporary base unit ringer off

While the base unit is ringing for a call, you can turn the ringer off temporarily by pressing **[⏏]**.

## Hold

This feature allows you to put an outside call on hold.

- 1 Press **[HOLD]** during an outside call.
  - If you are using the corded handset, you can place it on the cradle.
- 2 To release hold, lift the corded handset, or press **[HOLD]** or **[SP-PHONE]**.

### Note:

- If a call is kept on hold for more than 9 minutes, an alarm tone starts to sound. If the outside party hangs up the call, the unit disconnects the line and goes into standby mode.

## Making another call during a call

You can make a call using the other line by holding the 1st call.

- 1 Press **[HOLD]** to put the 1st call on hold.
  - If you are using the corded handset, place the corded handset on the cradle.

- 2 Dial the phone number.
- 3 Proceed with the desired operation.
  - **When you are using the corded handset:**  
Lift the corded handset.
  - **When you are using the speakerphone:**  
Press **[SP-PHONE]**.
- 4 To return to the 1st call, press **[SWITCH]**.

---

## Useful features during a call

---

### Mute

While mute is turned on, you can hear the other party, but the other party cannot hear you.

- 1 Press **[MUTE]** during an outside call.
- 2 To return to the conversation, press **[MUTE]** again.

---

### Call waiting

This feature allows you to receive calls while you are already talking on the phone. If you receive a call while on the phone, the 2nd caller's information is displayed on the base unit that is in use after you hear the interrupt tone (page 34). The feature depends on your phone system. Contact your administrator for further information.

- 1 Press **[SWITCH]** to answer the 2nd call.
- 2 To switch between calls, press **[SWITCH]**.

---

### Call share

#### Joining a call

You can join an existing outside call. Availability depends on your phone system. Contact your administrator for further information.

#### Important:

- The line must be set to allow other units to join through the Web user interface ("Privacy Mode").  is displayed on the unit currently in use when it is allowed to join the call. Contact your administrator for further information.
- 1 Press **[LINE STATUS]** when the handset is on an outside call.
  - 2 **[▼]/[▲]**: Select the desired line to join. → **[SELECT]**

---

### Sharing line numbers among multiple base units

If you have multiple base units, shared line number(s) may be assigned to selected units by your administrator. While the shared line is being used by other units,  is displayed when viewing the line status (page 10). Availability depends on your phone system. Contact your administrator for further information.

#### Note:

- This feature is explained as "Enable Shared Call" in the Web user interface.

---

## Transferring calls to an outside party

Outside calls can be transferred to an outside party. To transfer outside calls to a handset, see "Transferring calls", page 47.

- 1 During an outside call, press **[MENU]**.
- 2 **[▼]/[▲]**: "Transfer" → **[SELECT]**
- 3 Dial the phone number.
  - To correct the number, press **[CANCEL]** to clear the number and enter again.
- 4 Wait for the paged party to answer.
  - If the paged party does not answer, press **[CANCEL]** 2 times to return to the outside call.
- 5 **[TRANS]**

#### Note:

- In step 3, you can dial the phone number from the phonebook:  
 → **[▼]/[▲]**: Select the desired entry. → **[CALL]**

---

## Transferring a call without speaking to the outside party

- 1 During an outside call, press **[MENU]**.
- 2 **[▼]/[▲]**: "Blind transfer" → **[SELECT]**
- 3 Dial the phone number.
  - To correct the number, press **[CANCEL]** to clear the number and enter again.
- 4 **[TRANS]**
  - The outside call rings at the other unit.

**Note:**

- In step 3, you can dial the phone number from the phonebook:  
[📖] → [▼]/[▲]: Select the desired entry. → [CALL]

---

---

## Conference calls

Multiple people can establish a conference call.

- 1 During an outside call, press [MENU].
- 2 [▼]/[▲]: “Conference” → [SELECT]
- 3 Dial the phone number.
  - To correct the number, press [CANCEL] to clear the number and enter again.
- 4 Wait for the paged party to answer.
  - If the paged party does not answer, press [CANCEL] 2 times to return to the outside call.
- 5 [CONF]
  - If you want to add a new party to the conference, perform from step 1.

**Note:**

- In step 3, you can dial the phone number from the phonebook:  
[📖] → [▼]/[▲]: Select the desired entry. → [CALL]

## Using the phonebook

The phonebook allows you to make calls without having to dial manually. You can add 100 names and phone numbers to the phonebook.

## Adding entries

- 1 **[MENU]** (center of joystick)
- 2 **[▼]/[▲]**: “Phonebook” → **[SELECT]**
- 3 **[ADD]**
- 4 Enter the party's name (16 characters max.). → **[OK]**
- 5 Enter the party's phone number (32 digits max.). → **[OK]**
  - If you do not need to assign the ringer ID, go to step 8.
- 6 **[▼]/[▲]**: “Set Ringer ID” → **[SELECT]**
- 7 **[▼]/[▲]**: Select the desired setting (page 42). → **[OK]**
- 8 **[SAVE]**
  - To add other entries, repeat from step 4.
- 9 **[OFF]**

### Note:

- In step 3, you can also press **[MENU]**. → **[▼]/[▲]**: “New entry” → **[SELECT]**
- If you select “No Ringer ID” (default), the unit uses the ringer tone you selected on page 28 when a call is received from that caller.

## Character table for entering names

While entering characters, you can switch between uppercase and lowercase by pressing **[\*]**.

| Key | Character                      |
|-----|--------------------------------|
| [1] | Space # & ' ( )<br>* , - . / 1 |
| [2] | A B C 2<br>a b c 2             |
| [3] | D E F 3<br>d e f 3             |
| [4] | G H I 4<br>g h i 4             |

| Key | Character              |
|-----|------------------------|
| [5] | J K L 5<br>j k l 5     |
| [6] | M N O 6<br>m n o 6     |
| [7] | P Q R S 7<br>p q r s 7 |
| [8] | T U V 8<br>t u v 8     |
| [9] | W X Y Z 9<br>w x y z 9 |
| [0] | Space 0                |
| [#] | #                      |

- To enter another character that is located on the same dial key, push the joystick right to move the cursor to the next space.

## Correcting a mistake

Use the joystick to move the cursor to the character or number you want to erase, then press **[CLEAR]**. Enter the appropriate character or number.

- Press and hold **[CLEAR]** to erase all characters or numbers.

## Finding and calling a phonebook entry

### Scrolling through all entries

- 1 **[MENU]** (center of joystick)
- 2 **[▼]/[▲]**: “Phonebook” → **[SELECT]**
- 3 **[▼]/[▲]**: Select the desired entry.
- 4 **[↶]**
  - You can also select the line manually as follows:  
**[LINE]** → **[▼]/[▲]**: Select the desired line.  
→ Press **[CALL]** or **[↶]**.

### Searching by first character (alphabetically)

- 1 **[MENU]** (center of joystick)
- 2 **[▼]/[▲]**: “Phonebook” → **[SELECT]**

- 3 Press the dial key ([0] – [9], or [⦿]) which contains the character you are searching for (page 20).
  - Press the same dial key repeatedly to display the first entry corresponding to each character located on that dial key.
  - If there is no entry corresponding to the character you selected, the next entry is displayed.
- 4 [▼]/[▲]: Scroll through the phonebook if necessary.
- 5 [↶]
  - You can also select the line manually as follows:  
[LINE] → [▼]/[▲]: Select the desired line.  
→ Press [CALL] or [↶].

---

## Editing entries

- 1 Find the desired entry (page 20). → [MENU]
- 2 [▼]/[▲]: “Edit” → [SELECT]
- 3 Proceed with the desired operation.
  - To change the name or phone number:  
[▼]/[▲]: Select the name or phone number.  
→ [SELECT] → Edit the information (page 20). → [OK]
  - To change the ringer ID:  
[▼]/[▲]: Select the current ringer ID. → [SELECT] → [▼]/[▲]: Select the desired setting. → [OK]
    - To turn the ringer ID off, select “No Ringer ID”.
- 4 [SAVE] → [OFF]

---

## Erasing entries

---

### Erasing an entry

- 1 Find the desired entry (page 20). → [MENU]
- 2 [▼]/[▲]: “Erase” → [SELECT]
- 3 [▼]/[▲]: “Yes” → [SELECT] → [OFF]

---

### Erasing all entries

- 1 [MENU] (center of joystick)

- 2 [▼]/[▲]: “Phonebook” → [SELECT] → [MENU]
- 3 [▼]/[▲]: “Erase all items” → [SELECT]
- 4 [▼]/[▲]: “Yes” → [SELECT]
- 5 [▼]/[▲]: “Yes” → [SELECT] → [OFF]

---

## Chain dial

This feature allows you to dial phone numbers in the phonebook while you are on a call. This feature can be used, for example, to dial a calling card access number or bank account PIN that you have stored in the phonebook, without having to dial manually.

- 1 During an outside call, press [MENU].
- 2 [▼]/[▲]: “Phonebook” → [SELECT]
- 3 [▼]/[▲]: Select the desired entry.
- 4 Press [CALL] to dial the number.

---

## Speed dial

---

### Assigning an entry in the phonebook to a speed dial key



Dial keys [1] to [9] can each be used as a speed dial key, allowing you to dial a number from the phonebook by simply pressing a dial key.

- 1 Find the desired entry (page 20). → [MENU]
- 2 [▼]/[▲]: “Speed dial” → [SELECT]
- 3 [▼]/[▲]: Select the desired dial key number. → [SELECT]
  - If “Overwrite?” is displayed, the dial key you selected has a phone number already assigned to it.  
To overwrite with the currently selected phone number, go to step 4.  
To select another dial key, press [BACK], then repeat this step.
- 4 [▼]/[▲]: “Yes” → [SELECT] → [OFF]

#### Note:

- Where a dial key is already being used for speed dialing, “✓” is displayed next to the dial key number.

### Making a call using a speed dial key

- 1 Press and hold the desired speed dial key ([1] – [9]).
  - You can view other speed dial assignments by pushing the joystick down or up.
- 2 [  
  - You can also select the line manually as follows:  
[LINE] → [▼]/[▲]: Select the desired line.  
→ Press [CALL] or [].

---

### Canceling a speed dial assignment

- 1 Press and hold the desired speed dial key ([1] – [9]). → [ERASE]
- 2 [▼]/[▲]: “Yes” → [SELECT] → [OFF]

---

## Export/import phonebook entries

You can export the phonebook entries through the Web user interface to your computer as a tab separated value file. It makes it possible to add, edit, or erase phonebook entries more conveniently on a spreadsheet (.csv) using Microsoft® Excel®, for example, on your computer. After editing, the file should be imported to the unit. To export/import entries, contact your administrator.

### Important:

- Entries deleted on your computer are not replicated in the phonebook of the unit when importing. Erase unnecessary entries with your unit, not through the Web user interface.

## Using the phonebook

The phonebook allows you to make calls without having to dial manually. You can add 100 names and phone numbers to the phonebook.

## Adding entries

- 1  (left soft key)
- 2 **[ADD]**
- 3 Enter the party's name (16 characters max.). → **[OK]**
- 4 Enter the party's phone number (32 digits max.). → **[OK]**
  - If you do not need to assign the ringer ID, go to step 7.
- 5 **[▼]/[▲]**: "Set Ringer ID" → **[SELECT]**
- 6 **[▼]/[▲]**: Select the desired setting (page 42). → **[OK]**
- 7 **[SAVE]**
  - To add other entries, repeat from step 3.
- 8 **[EXIT]**

### Note:

- In step 2, you can also press **[MENU]**. → **[▼]/[▲]**: "New entry" → **[SELECT]**
- If you select "No Ringer ID" (default), the unit uses the ringer tone you selected on page 34 when a call is received from that caller.

## Character table for entering names

While entering characters, you can switch between uppercase and lowercase by pressing **[\*]**.

| Key | Character                      |
|-----|--------------------------------|
| [1] | Space # & ' ( )<br>* , - . / 1 |
| [2] | A B C 2<br>a b c 2             |
| [3] | D E F 3<br>d e f 3             |
| [4] | G H I 4<br>g h i 4             |

| Key | Character              |
|-----|------------------------|
| [5] | J K L 5<br>j k l 5     |
| [6] | M N O 6<br>m n o 6     |
| [7] | P Q R S 7<br>p q r s 7 |
| [8] | T U V 8<br>t u v 8     |
| [9] | W X Y Z 9<br>w x y z 9 |
| [0] | Space 0                |
| [#] | #                      |

- To enter another character that is located on the same dial key, press **[▶]** to move the cursor to the next space.

## Correcting a mistake

Press **[←]** or **[▶]** to move the cursor to the character or number you want to erase, then press **[CLEAR]**. Enter the appropriate character or number.

- Press and hold **[CLEAR]** to erase all characters or numbers.

## Finding and calling a phonebook entry

### Scrolling through all entries

- 1  (left soft key)
- 2 **[▼]/[▲]**: Select the desired entry.
- 3 Lift the corded handset.
  - You can also select the line manually as follows:  
**[LINE]** → **[▼]/[▲]**: Select the desired line.  
→ Lift the corded handset.

### Searching by first character (alphabetically)

- 1  (left soft key)
- 2 Press the dial key (**[0]** – **[9]**, or **[#]**) which contains the character you are searching for (page 23).

- Press the same dial key repeatedly to display the first entry corresponding to each character located on that dial key.
  - If there is no entry corresponding to the character you selected, the next entry is displayed.
- 3** [▼]/[▲]: Scroll through the phonebook if necessary.
- 4** Lift the corded handset.
- You can also select the line manually as follows:  
[LINE] → [▼]/[▲]: Select the desired line.  
→ Lift the corded handset.

---

## Editing entries

- Find the desired entry (page 23). → [MENU]
- [▼]/[▲]: "Edit" → [SELECT]
- Proceed with the desired operation.
  - To change the name or phone number:**  
[▼]/[▲]: Select the name or phone number.  
→ [SELECT] → Edit the information (page 23). → [OK]
  - To change the ringer ID:**  
[▼]/[▲]: Select the current ringer ID. → [SELECT] → [▼]/[▲]: Select the desired setting. → [OK]
    - To turn the ringer ID off, select "No Ringer ID".
- [SAVE] → [EXIT]

---

## Erasing entries

---

### Erasing an entry

- Find the desired entry (page 23). → [ERASE]
- [▼]/[▲]: "Yes" → [SELECT] → [EXIT]

---

### Erasing all entries

- [☒] (left soft key) → [MENU]
- [▼]/[▲]: "Erase all items" → [SELECT]
- [▼]/[▲]: "Yes" → [SELECT]

- [▼]/[▲]: "Yes" → [SELECT] → [EXIT]

---

## Chain dial

This feature allows you to dial phone numbers in the phonebook while you are on a call. This feature can be used, for example, to dial a calling card access number or bank account PIN that you have stored in the phonebook, without having to dial manually.

- During an outside call, press [☒].
- [▼]/[▲]: Select the desired entry.
- Press [CALL] to dial the number.

---

## Speed dial

---

### Assigning an entry in the phonebook to a speed dial key

Dial keys [1] to [9] can each be used as a speed dial key, allowing you to dial a number from the phonebook by simply pressing a dial key.

- Find the desired entry (page 23). → [MENU]
- [▼]/[▲]: "Speed dial" → [SELECT]
- [▼]/[▲]: Select the desired dial key number. → [SELECT]
  - If "Overwrite?" is displayed, the dial key you selected has a phone number already assigned to it.  
To overwrite with the currently selected phone number, go to step 4.  
To select another dial key, press [BACK], then repeat this step.

- [▼]/[▲]: "Yes" → [SELECT] → [EXIT]

#### Note:

- Where a dial key is already being used for speed dialing, "✓" is displayed next to the dial key number.

---

### Making a call using a speed dial key

- Press and hold the desired speed dial key ([1] – [9]).
  - You can view other speed dial assignments by pressing [▼] or [▲].
- Lift the corded handset.



- You can also select the line manually as follows:  
[LINE] → [▼]/[▲]: Select the desired line.  
→ Lift the corded handset.

---

### Canceling a speed dial assignment

- 1 Press and hold the desired speed dial key ([1] – [9]). → [ERASE]
- 2 [▼]/[▲]: “Yes” → [SELECT] → [EXIT]

---

## Copying base unit phonebook entries

You can copy base unit phonebook entries to the phonebook of a handset.

### Note:

- Ringer ID for phonebook entries are not copied.
- You can copy handset phonebook entries to another handset or base unit by exporting the data to a computer and importing it (page 25).

---

### Copying an entry

- 1 Find the desired entry (page 23). → [MENU]
- 2 [▼]/[▲]: “Copy” → [SELECT]
- 3 Enter the handset number you wish to send the phonebook entry to.
  - When an entry has been copied, “Completed” is displayed.
  - To continue copying another entry:  
[▼]/[▲]: “Yes” → [SELECT] → Find the desired entry. → [SEND]
- 4 [EXIT]

---

### Copying all entries

- 1 [☰] (left soft key) → [MENU]
- 2 [▼]/[▲]: “Copy all items” → [SELECT]
- 3 Enter the handset number you wish to send the phonebook entry to.
  - When all entries have been copied, “Completed” is displayed.
- 4 [EXIT]

---

## Export/import phonebook entries

You can export the phonebook entries through the Web user interface to your computer as a tab separated value file. It makes it possible to add, edit, or erase phonebook entries more conveniently on a spreadsheet (.csv) using Microsoft Excel, for example, on your computer. After editing, the file should be imported to the unit. To export/import entries, contact your administrator.

### Important:

- Entries deleted on your computer are not replicated in the phonebook of the unit when importing. Erase unnecessary entries with your unit, not through the Web user interface.

## Programmable settings

You can customize the unit by programming the following features.

To access the features, there are 2 methods:

- scrolling through the display menus (page 26)
- using the direct commands (page 27)

Some of the features can be programmed through the Web user interface (page 40).





- Direct command is the main method used in this User Guide.



### Programming by scrolling through the display menus

- 1 **[MENU]** (center of joystick)
- 2 Select the desired main menu by pushing the joystick in any direction. → **[SELECT]**
- 3 Push the joystick down or up to select the desired item in sub-menu 1. → **[SELECT]**
  - In some cases, you may need to select from sub-menu 2. → **[SELECT]**
- 4 Push the joystick down or up to select the desired setting. → **[SAVE]**
  - This step may vary depending on the feature being programmed.
  - To exit the operation, press **[OFF]**.

#### Note:

- See page 27 for the default settings.
- In the following table, ( ) indicates lines you need to select for the settings.

| Main menu  | Sub-menu 1      | Sub-menu 2   | Page   |
|--|-----------------|--|--------|
| Line status<br>      | –               | –  | 10     |
| IP service<br>       | Network setting | DHCP <sup>*1</sup>   | –      |
|  |                 | IP settings <sup>*1</sup>  | –      |
|  |                 | Embedded web   | 40     |
|  | Call features   | Call forward<br>(Line 1: 8 max.)<br>– Unconditional <sup>*1</sup><br>– Busy <sup>*1</sup><br>– No answer <sup>*1</sup> | 29     |
|  |                 | Do not disturb <sup>*1</sup><br>(Line 1: 8 max.)   | 30     |
|  |                 | Block anonymous <sup>*1</sup><br>(Line 1: 8 max.)  | 30     |
|  |                 | Block Caller ID <sup>*1</sup><br>(Line 1: 8 max.)  | 31     |
| New Voice Mail<br> | –               | –  | 44     |
| Intercom<br>       | –               | –  | 45, 46 |

| Main menu  | Sub-menu 1                  | Sub-menu 2                      | Page |
|--|-----------------------------|---------------------------------|------|
| Initial settings<br> | Ringer settings             | Ringer volume                   | 13   |
|  |                             | Ringer tone<br>(Line 1: 8 max.) | -    |
|  |                             | Interrupt tone                  | -    |
|  | Date and time <sup>*1</sup> | -                               | 31   |
|  | Call block <sup>*1</sup>    | -                               | 30   |
|  | Auto Intercom               | -                               | 45   |
|  | LCD contrast                | -                               | -    |
|  | Key tone                    | -                               | -    |
|  | Auto talk                   | -                               | 13   |
|  | Message alert               | -                               | 44   |
|  | Registration                | Register handset                | 41   |
|  |                             | Deregistration                  | 41   |
|  | Handset name                | -                               | 31   |
|  | Change language             | -                               | 10   |
| Software version <sup>*1</sup>   | -                           | 32                              |      |
| Phonebook<br>        | -                           | -                               | 20   |

\*1 If you program these settings using one of the handsets, you do not need to program the same item using another unit.

## Programming using the direct commands

- 1 **[MENU]** (center of joystick) → **[⇄]**
- 2 Enter the desired feature code.
- 3 **[▼]/[▲]**: Select the desired setting. → **[SAVE]**
  - This step may vary depending on the feature being programmed.
  - To exit the operation, press **[OFF]**.

### Note:

- In the following table, < > indicates the default settings and ( ) indicates lines you need to select for the settings.

| Feature                 | Feature code | Setting code  | System setting <sup>*1</sup> | Page |
|-------------------------|--------------|---|------------------------------|------|
| Auto Intercom           | [2][7][3]    | [1]: On (Ringer On)<br>[2]: On (Ringer Off)<br>[0]: <Off> | -                            | 45   |
| Auto talk <sup>*2</sup> | [2][0][0]    | [1]: On<br>[0]: <Off>                                     | -                            | 13   |
| Call block              | [2][1][7]    | -   | ●                            | 30   |
| Change language         | [1][1][0]    | [1]: <English><br>[2]: Español                            | -                            | 10   |
| Date and time           | [1][0][1]    | -   | ●                            | 31   |
| Deregistration          | [1][3][1]    | -   | -                            | 41   |

| Feature                            | Feature code | Setting code  | System setting <sup>*1</sup> | Page          |
|------------------------------------|--------------|---|------------------------------|---------------|
| DHCP <sup>*3</sup>                 | [5][0][0]    | [1]: <On><br>[0]: Off   | ●                            | –             |
| Embedded web                       | [5][3][4]    | [1]: On<br>[0]: <Off>   | –                            | 40            |
| Handset name                       | [1][0][4]    | –   | –                            | 31            |
| Intercom call                      | [2][7][4]    | –   | –                            | 45, 46        |
| Interrupt tone <sup>*4</sup>       | [2][0][1]    | [1]: <On><br>[0]: Off   | –                            | 14, 45,<br>46 |
| IP settings <sup>*3</sup>          | [5][0][1]    | –   | ●                            | –             |
| Key tone <sup>*5</sup>             | [1][6][5]    | [1]: <On><br>[0]: Off   | –                            | –             |
| LCD contrast<br>(Display contrast) | [1][4][5]    | [1] – [6]: Level 1–6 <3>  | –                            | –             |
| Message alert                      | [3][4][0]    | [1]: On<br>[0]: <Off>   | –                            | 44            |
| Phonebook                          | [2][8][0]    | –   | –                            | 20            |
| Register handset                   | [1][3][0]    | –   | –                            | 41            |
| Ringer tone                        | [1][6][1]    | (Line 1: [1] – [6]: Tone <1>–6<br>8 max.) [7] – [9]: Melody 1–3 | –                            | –             |
| Ringer volume <sup>*6</sup>        | [1][6][0]    | [1] – [6]: Level 1–<6><br>[0]: Off                              | –                            | 13            |
| Software version                   | [1][5][6]    | –   | ●                            | 32            |
| New Voice Mail                     | [3][3][0]    | –   | –                            | 44            |

\*1 If you program these settings using one of the handsets, you do not need to program the same item using another unit.

\*2 If you want to view the caller's information after lifting up the handset to answer a call, turn off this feature.

\*3 We recommend programming this setting with your administrator. Contact your administrator for further information.

\*4 This tone lets you know when you receive an outside call while you are on the other outside call or an intercom call.

\*5 Turn this feature off if you prefer not to hear key tones while you are dialing or pressing any keys, including confirmation tones and error tones.

\*6 When the ringer volume is turned off,  $\mathcal{Z}$  is displayed and the handset does not ring for outside calls. However even when the ringer volume is set to off, the handset rings at the lowest level for intercom calls (page 45, 46) and paging (page 47).

---

## Call forward

Incoming calls can be forwarded to another party. You can choose one of 3 modes:

- “**Unconditional**”: All incoming calls are forwarded.
- “**Busy**”: Incoming calls while the line is in use are forwarded.
- “**No answer**”: Incoming calls after a certain number of rings are forwarded. The default setting of the number of ring count is “3”. To change the setting, perform “Changing the ring count”, page 29.

### Important:

- We recommend setting with your administrator. Contact your administrator for further information.
- If this feature is set on your unit, it may be overridden by your phone system settings.
- This feature is not available on shared lines.
- The call is logged in the caller list (page 42) with ✓ after the call is forwarded.

---

## Turning call forward on/off

- 1 **[MENU]** (center of joystick)
- 2 **[▼]/[▲]**: “IP service” → **[SELECT]**
- 3 **[▼]/[▲]**: “Call features” → **[SELECT]**
- 4 **[▼]/[▲]**: “Call forward” → **[SELECT]**
- 5 Proceed with the desired operation.
  - **When 1 line is registered:**  
Go to step 6.
  - **When 2 or more lines are registered:**  
**[▼]/[▲]**: Select the desired line. → **[SELECT]**
- 6 **[▼]/[▲]**: Select the desired option. → **[SELECT]**
- 7 **[▼]/[▲]**: “On/Off” → **[SELECT]**
- 8 **[▼]/[▲]**: Select “On” or “Off”. → **[SAVE]**
  - If you select “Off”, press **[OFF]** to exit.
  - If the phone number forwarded to has been already set, press **[OFF]** to exit. To change the phone number, perform from step 7, “Changing the phone number”, page 29, then press **[OFF]** to exit.
- 9 Enter the phone number you want to forward calls to (24 digits max.). → **[SAVE]**

- If you have selected “No answer”, enter the number of rings before the unit forwards calls (0, 2-20 rings). → **[SAVE]**

## 10 [OFF]

---

## Changing the phone number

- 1 **[MENU]** (center of joystick)
- 2 **[▼]/[▲]**: “IP service” → **[SELECT]**
- 3 **[▼]/[▲]**: “Call features” → **[SELECT]**
- 4 **[▼]/[▲]**: “Call forward” → **[SELECT]**
- 5 Proceed with the desired operation.
  - **When 1 line is registered:**  
Go to step 6.
  - **When 2 or more lines are registered:**  
**[▼]/[▲]**: Select the desired line. → **[SELECT]**
- 6 **[▼]/[▲]**: Select the desired option. → **[SELECT]**
- 7 **[▼]/[▲]**: “Phone number” → **[SELECT]**
- 8 Enter the phone number you want to forward calls to (24 digits max.). → **[SAVE]** → **[OFF]**

---

## Changing the ring count

You can change the number of rings before which the call is forwarded if “No answer” is selected.

- 1 **[MENU]** (center of joystick)
- 2 **[▼]/[▲]**: “IP service” → **[SELECT]**
- 3 **[▼]/[▲]**: “Call features” → **[SELECT]**
- 4 **[▼]/[▲]**: “Call forward” → **[SELECT]**
- 5 Proceed with the desired operation.
  - **When 1 line is registered:**  
Go to step 6.
  - **When 2 or more lines are registered:**  
**[▼]/[▲]**: Select the desired line. → **[SELECT]**
- 6 **[▼]/[▲]**: “No answer” → **[SELECT]**
- 7 **[▼]/[▲]**: “Ring count” → **[SELECT]**
- 8 Enter the number of rings before the unit forwards calls (0, 2-20 rings). → **[SAVE]** → **[OFF]**

---

## Do not disturb

This feature allows the unit to reject calls on selected lines.

The default setting is “off”.

### Important:

- We recommend setting with your administrator. Contact your administrator for further information.
- If this feature is set on your unit, it may be overridden by your phone system settings.
- This feature is not available on shared lines.
- The call is logged in the caller list (page 42) with ✓ after the call is rejected.

- 1 **[MENU]** (center of joystick)
- 2 **[▼]/[▲]**: “IP service” → **[SELECT]**
- 3 **[▼]/[▲]**: “Call features” → **[SELECT]**
- 4 **[▼]/[▲]**: “Do not disturb” → **[SELECT]**
- 5 Proceed with the desired operation.
  - **When 1 line is registered:**  
Go to step 6.
  - **When 2 or more lines are registered:**  
**[▼]/[▲]**: Select the desired line. → **[SELECT]**
- 6 **[▼]/[▲]**: Select “on” or “off”. → **[SAVE]**  
→ **[OFF]**

---

## Block anonymous calls

This feature allows the unit to reject calls when the unit receives a call without phone number.

The default setting is “off”.

### Important:

- We recommend setting with your administrator. Contact your administrator for further information.
- This feature is not available on shared lines.
- The call is logged in the caller list (page 42) with ✓ after the call is rejected.

- 1 **[MENU]** (center of joystick)
- 2 **[▼]/[▲]**: “IP service” → **[SELECT]**
- 3 **[▼]/[▲]**: “Call features” → **[SELECT]**
- 4 **[▼]/[▲]**: “Block anonymous” → **[SELECT]**
- 5 Proceed with the desired operation.

### ■ When 1 line is registered:

Go to step 6.

### ■ When 2 or more lines are registered:

**[▼]/[▲]**: Select the desired line. → **[SELECT]**

- 6 **[▼]/[▲]**: Select “on” or “off”. → **[SAVE]**  
→ **[OFF]**

---

## Call block (Caller ID service users only)

This feature allows the unit to reject calls from specified phone numbers that you do not want to answer such as junk calls.

When a call is received, the unit does not ring while the caller is being identified. If the phone number matches an entry in the call block list, the unit rejects the call.

### Important:

- When the unit receives a call from a number that is stored in the call block list, the call is logged in the caller list (page 42) with ✗ after the call is rejected.

---

## Storing unwanted callers

You can store up to 30 phone numbers in the call block list by using the caller list or by entering the numbers directly.

### Important:

- You are advised to store the 10 digits (including an area code) for PSTN calls because if 7 digits are stored, all numbers that have the last 7 digits will be blocked.

### From the caller list:

- 1 **[CID]** (left soft key)
- 2 **[▼]/[▲]**: Select the entry to be blocked. → **[MENU]**
- 3 **[▼]/[▲]**: “Save call block” → **[SELECT]**
- 4 **[▼]/[▲]**: “Yes” → **[SELECT]** → **[OFF]**

### By entering phone numbers:

- 1 **[MENU]** (center of joystick) → **[#][2][1][7]** → **[ADD]**
- 2 Enter the phone number (24 digits max.). → **[SAVE]**
  - To erase a digit, press **[CLEAR]**.

### 3 [OFF]

#### Viewing/editing/erasing call block numbers

- 1 **[MENU]** (center of joystick) → **[#][2][1][7]**
- 2 **[v]/[▲]**: Select the desired entry.
  - To exit, press **[OFF]**.
- 3 Proceed with the desired operation.
  - **Editing a number:**  
**[MENU]** → **[v]/[▲]**: “Edit” → **[SELECT]** → Edit the phone number. → **[SAVE]** → **[OFF]**
  - **Erasing a number:**  
**[MENU]** → **[v]/[▲]**: “Erase” → **[SELECT]** → **[v]/[▲]**: “Yes” → **[SELECT]** → **[OFF]**

**Note:**

- When editing, press the desired dial key to add, **[CLEAR]** to erase.

## Anonymous calls (Block Caller ID)

This feature allows the unit to make a call anonymously.

The default setting is “off”.

**Important:**

- We recommend setting with your administrator. Contact your administrator for further information.

- 1 **[MENU]** (center of joystick)
- 2 **[v]/[▲]**: “IP service” → **[SELECT]**
- 3 **[v]/[▲]**: “Call features” → **[SELECT]**
- 4 **[v]/[▲]**: “Block Caller ID” → **[SELECT]**
- 5 Proceed with the desired operation.
  - **When 1 line is registered:**  
Go to step 6.
  - **When 2 or more lines are registered:**  
**[v]/[▲]**: Select the desired line. → **[SELECT]**
- 6 **[v]/[▲]**: Select “On” or “off”. → **[SAVE]** → **[OFF]**

## Changing the handset name

Each handset can be given a customized name (“Bob”, “Kitchen”, etc.). This is useful when you make intercom calls between handsets. You can also select whether or not the handset name is displayed in standby mode. The default setting is “off”. If you select “on” without entering any handset name, “Handset 1” to “Handset 6” is displayed.

- 1 **[MENU]** (center of joystick) → **[#][1][0][4]**
- 2 Enter the desired name (10 characters max.; see the character table, page 20).
  - If not required, go to step 3.
- 3 **[OK]**
- 4 **[v]/[▲]**: “on” → **[SAVE]** → **[OFF]**

## Date and time

Set if the unit does not show the date and time. You can set the date and time through the Web user interface and also program it to adjust automatically using the SNTP. Also daylight saving time setting is available through the Web user interface. Contact your administrator for further information.

- 1 **[MENU]** (center of joystick) → **[#][1][0][1]**
- 2 Enter the current month, date, and year.  
**Example:** March 15, 2010  
**[0][3][1][5][1][0]**
- 3 Enter the current hour and minute (12-hour clock format).  
**Example:** 9:30  
**[0][9][3][0]**
- 4 **[AM/PM]**: Select “AM” or “PM”.
- 5 **[SAVE]** → **[OFF]**

**Note:**

- When English is selected as the display language, 12-hour clock format is used. When Spanish is selected, 24-hour clock format is used.
- To correct a digit, push the joystick left, right, up, or down to move the cursor to the digit, then make the correction.

---

## Updating the base unit software

Your phone system dealer may offer new features and improve its software version from time to time. If you set the base unit software update setting to manual mode through the Web user interface, you need to download the update when “**Update version. Press OK.**” is displayed. Contact your administrator for further information.

### Important:

- Make sure the STATUS indicator on the base unit is lit in green and no line is in use (page 8).

- 1 Press **[OK↵]** while “**Update version. Press OK.**” is displayed.
  - The current and new base unit software versions are displayed.
  - If you want to download the update later, press **[CANCEL]**. When you are ready to download, see “Confirming the base unit software version”, page 32.

### 2 **[OK]**

### Note:

- The STATUS indicator on the base unit flashes while downloading. When the download is complete, the STATUS indicator stops flashing and changes to steady green.

---

## Confirming the base unit software version

- 1 **[MENU]** (center of joystick) → **[⇄][1][5][6]**
  - The current base unit software version is displayed. To exit, press **[OFF]**.
- 2 If “**Update version?**” is displayed, press **[OK]** to download. To exit without downloading, press **[CANCEL]**.



## Programmable settings

You can customize the unit by programming the following features.

To access the features, there are 2 methods:

- scrolling through the display menus (page 33)
- using the direct commands (page 34)

Some of the features can be programmed through the Web user interface (page 40).



- Direct command is the main method used in this User Guide.



### Programming by scrolling through the display menus

- 1 **[MENU]** (middle soft key)
- 2 Press **[▲]**, **[▼]**, **[◀]**, or **[▶]** to select the desired main menu. → **[SELECT]**
- 3 Press **[▼]** or **[▲]** to select the desired item in sub-menu 1. → **[SELECT]**
  - In some cases, you may need to select from sub-menu 2. → **[SELECT]**
- 4 Press **[▼]** or **[▲]** to select the desired setting. → **[SAVE]**
  - This step may vary depending on the feature being programmed.
  - To exit the operation, press **[EXIT]**.

#### Note:

- See page 34 for the default settings.
- In the following table, ( ) indicates lines you need to select for the settings.

| Main menu   | Sub-menu 1      | Sub-menu 2   | Page |
|---|-----------------|--|------|
| Line status<br>       | –               | –  | 10   |
| IP service<br>        | Network setting | DHCP <sup>*1</sup>   | –    |
|   |                 | IP settings <sup>*1</sup>  | –    |
|   |                 | Embedded web   | 40   |
|   | Call features   | Call forward<br>(Line 1: 8 max.)<br>– Unconditional <sup>*1</sup><br>– Busy <sup>*1</sup><br>– No answer <sup>*1</sup> | 36   |
|   |                 | Do not disturb <sup>*1</sup><br>(Line 1: 8 max.)   | 37   |
|   |                 | Block anonymous <sup>*1</sup><br>(Line 1: 8 max.)  | 37   |
|   |                 | Block Caller ID <sup>*1</sup><br>(Line 1: 8 max.)  | 38   |
| Ringer settings<br> | Ringer volume   | –  | 17   |
|   | Ringer tone     | (Line 1: 8 max.)   | –    |
|   | Interrupt tone  | –  | –    |

| Main menu  | Sub-menu 1                     | Sub-menu 2 | Page |
|--|--------------------------------|------------|------|
| Initial settings<br> | Date and time <sup>*1</sup>    | –          | 38   |
|  | Call block <sup>*1</sup>       | –          | 37   |
|  | LCD contrast                   | –          | –    |
|  | Change language                | –          | 10   |
|  | Software version <sup>*1</sup> | –          | 38   |
| Phonebook<br>        | –                              | –          | 23   |
| Caller list<br>      | –                              | –          | 42   |

\*1 If you program these settings using the base unit, you do not need to program the same item using a handset.

## Programming using the direct commands

- 1 **[MENU]** (middle soft key) → **[#]**
- 2 Enter the desired feature code.
- 3 **[v]/[▲]**: Select the desired setting. → **[SAVE]**
  - This step may vary depending on the feature being programmed.
  - To exit the operation, press **[EXIT]**.

### Note:

- In the following table, < > indicates the default settings and ( ) indicates lines you need to select for the settings.

| Feature                            | Feature code | Setting code  | System setting <sup>*1</sup> | Page   |
|------------------------------------|--------------|---|------------------------------|--------|
| Call block                         | [2][1][7]    | –   | ●                            | 37     |
| Change language                    | [1][1][0]    | [1]: <English><br>[2]: Español                                  | –                            | 10     |
| Date and time                      | [1][0][1]    | –   | ●                            | 38     |
| DHCP <sup>*2</sup>                 | [5][0][0]    | [1]: <On><br>[0]: Off   | ●                            | –      |
| Embedded web                       | [5][3][4]    | [1]: On<br>[0]: <Off>   | –                            | 40     |
| Interrupt tone <sup>*3</sup>       | [2][0][1]    | [1]: <On><br>[0]: Off   | –                            | 18, 46 |
| IP settings <sup>*2</sup>          | [5][0][1]    | –   | ●                            | –      |
| LCD contrast<br>(Display contrast) | [1][4][5]    | [1] – [6]: Level 1–6 <3>  | –                            | –      |
| Phonebook                          | [2][8][0]    | –   | –                            | 23     |
| Ringer tone                        | [1][6][1]    | (Line 1: [1] – [6]: Tone <1>–6<br>8 max.) [7] – [9]: Melody 1–3 | –                            | –      |
| Ringer volume <sup>*4</sup>        | [1][6][0]    | [1] – [3]: Level 1–<3><br>[0]: Off                              | –                            | 17     |
| Software version                   | [1][5][6]    | –   | ●                            | 38     |

## **Programming using the Base Unit (KX-TGP550 only)**

---

- \*1 If you program these settings using the base unit, you do not need to program the same item using a handset.
- \*2 We recommend programming this setting with your administrator. Contact your administrator for further information.
- \*3 This tone lets you know when you receive an outside call while you are on the other outside call or an intercom call.
- \*4 When the ringer volume is turned off,  $\mu$  is displayed and the base unit does not ring for outside calls. However even when the ringer volume is set to off, the base unit rings at the low level for intercom calls (page 46).

---

## Call forward

Incoming calls can be forwarded to another party. You can choose one of 3 modes:

- “**Unconditional**”: All incoming calls are forwarded.
- “**Busy**”: Incoming calls while the line is in use are forwarded.
- “**No answer**”: Incoming calls after a certain number of rings are forwarded. The default setting of the number of ring count is “3”. To change the setting, perform “Changing the ring count”, page 36.

### Important:

- We recommend setting with your administrator. Contact your administrator for further information.
- If this feature is set on your unit, it may be overridden by your phone system settings.
- This feature is not available on shared lines.
- The call is logged in the caller list (page 42) with ✓ after the call is forwarded.

---

## Turning call forward on/off

- 1 **[MENU]** (middle soft key)
- 2 **[▼]/[▲]**: “IP service” → **[SELECT]**
- 3 **[▼]/[▲]**: “Call features” → **[SELECT]**
- 4 **[▼]/[▲]**: “Call forward” → **[SELECT]**
- 5 Proceed with the desired operation.
  - **When 1 line is registered:**  
Go to step 6.
  - **When 2 or more lines are registered:**  
**[▼]/[▲]**: Select the desired line. → **[SELECT]**
- 6 **[▼]/[▲]**: Select the desired option. → **[SELECT]**
- 7 **[▼]/[▲]**: “On/Off” → **[SELECT]**
- 8 **[▼]/[▲]**: Select “On” or “Off”. → **[SAVE]**
  - If you select “Off”, press **[EXIT]** to exit.
  - If the phone number forwarded to has been already set, press **[EXIT]** to exit. To change the phone number, perform from step 7, “Changing the phone number”, page 36, then press **[EXIT]** to exit.
- 9 Enter the phone number you want to forward calls to (24 digits max.). → **[SAVE]**

- If you have selected “No answer”, enter the number of rings before the unit forwards calls (0, 2-20 rings). → **[SAVE]**

## 10 [EXIT]

---

## Changing the phone number

- 1 **[MENU]** (middle soft key)
- 2 **[▼]/[▲]**: “IP service” → **[SELECT]**
- 3 **[▼]/[▲]**: “Call features” → **[SELECT]**
- 4 **[▼]/[▲]**: “Call forward” → **[SELECT]**
- 5 Proceed with the desired operation.
  - **When 1 line is registered:**  
Go to step 6.
  - **When 2 or more lines are registered:**  
**[▼]/[▲]**: Select the desired line. → **[SELECT]**
- 6 **[▼]/[▲]**: Select the desired option. → **[SELECT]**
- 7 **[▼]/[▲]**: “Phone number” → **[SELECT]**
- 8 Enter the phone number you want to forward calls to (24 digits max.). → **[SAVE]** → **[EXIT]**

---

## Changing the ring count

You can change the number of rings before which the call is forwarded if “No answer” is selected.

- 1 **[MENU]** (middle soft key)
- 2 **[▼]/[▲]**: “IP service” → **[SELECT]**
- 3 **[▼]/[▲]**: “Call features” → **[SELECT]**
- 4 **[▼]/[▲]**: “Call forward” → **[SELECT]**
- 5 Proceed with the desired operation.
  - **When 1 line is registered:**  
Go to step 6.
  - **When 2 or more lines are registered:**  
**[▼]/[▲]**: Select the desired line. → **[SELECT]**
- 6 **[▼]/[▲]**: “No answer” → **[SELECT]**
- 7 **[▼]/[▲]**: “Ring count” → **[SELECT]**
- 8 Enter the number of rings before the unit forwards calls (0, 2-20 rings). → **[SAVE]** → **[EXIT]**

---

## Do not disturb

This feature allows the unit to reject calls on selected lines.

The default setting is “off”.

### Important:

- We recommend setting with your administrator. Contact your administrator for further information.
- If this feature is set on your unit, it may be overridden by your phone system settings.
- This feature is not available on shared lines.
- The call is logged in the caller list (page 42) with ✓ after the call is rejected.

- 1 **[MENU]** (middle soft key)
- 2 **[▼]/[▲]**: “IP service” → **[SELECT]**
- 3 **[▼]/[▲]**: “Call features” → **[SELECT]**
- 4 **[▼]/[▲]**: “Do not disturb” → **[SELECT]**
- 5 Proceed with the desired operation.

#### ■ When 1 line is registered:

Go to step 6.

#### ■ When 2 or more lines are registered:

**[▼]/[▲]**: Select the desired line. → **[SELECT]**

- 6 **[▼]/[▲]**: Select “on” or “off”. → **[SAVE]** → **[EXIT]**

---

## Block anonymous calls

This feature allows the unit to reject calls when the unit receives a call without phone number.

The default setting is “off”.

### Important:

- We recommend setting with your administrator. Contact your administrator for further information.
- This feature is not available on shared lines.
- The call is logged in the caller list (page 42) with ✓ after the call is rejected.

- 1 **[MENU]** (middle soft key)
- 2 **[▼]/[▲]**: “IP service” → **[SELECT]**
- 3 **[▼]/[▲]**: “Call features” → **[SELECT]**
- 4 **[▼]/[▲]**: “Block anonymous” → **[SELECT]**
- 5 Proceed with the desired operation.

#### ■ When 1 line is registered:

Go to step 6.

#### ■ When 2 or more lines are registered:

**[▼]/[▲]**: Select the desired line. → **[SELECT]**

- 6 **[▼]/[▲]**: Select “on” or “off”. → **[SAVE]** → **[EXIT]**

---

## Call block (Caller ID service users only)

This feature allows the unit to reject calls from specified phone numbers that you do not want to answer such as junk calls.

When a call is received, the unit does not ring while the caller is being identified. If the phone number matches an entry in the call block list, the unit rejects the call.

### Important:

- When the unit receives a call from a number that is stored in the call block list, the call is logged in the caller list (page 42) with ✗ after the call is rejected.

---

## Storing unwanted callers

You can store up to 30 phone numbers in the call block list by using the caller list or by entering the numbers directly.

### Important:

- You are advised to store the 10 digits (including an area code) for PSTN calls because if 7 digits are stored, all numbers that have the last 7 digits will be blocked.

#### From the caller list:

- 1 **[CID]** (right soft key)
- 2 **[▼]/[▲]**: Select the entry to be blocked. → **[MENU]**
- 3 **[▼]/[▲]**: “Save call block” → **[SELECT]**
- 4 **[▼]/[▲]**: “Yes” → **[SELECT]** → **[EXIT]**

#### By entering phone numbers:

- 1 **[MENU]** (middle soft key) → **[#][2][1][7]** → **[ADD]**
- 2 Enter the phone number (24 digits max.). → **[SAVE]**
  - To erase a digit, press **[CLEAR]**.

**3 [EXIT]****Viewing/editing/erasing call block numbers**

- 1 **[MENU]** (middle soft key) → **[#][2][1][7]**
- 2 **[▼]/[▲]**: Select the desired entry.
  - To exit, press **[EXIT]**.
- 3 Proceed with the desired operation.
  - **Editing a number:**  
**[MENU]** → **[▼]/[▲]**: “Edit” →  
**[SELECT]** → Edit the phone number. →  
**[SAVE]** → **[EXIT]**
  - **Erasing a number:**  
**[MENU]** → **[▼]/[▲]**: “Erase” →  
**[SELECT]** → **[▼]/[▲]**: “Yes” →  
**[SELECT]** → **[EXIT]**

**Note:**

- When editing, press the desired dial key to add, **[CLEAR]** to erase.

**Anonymous calls (Block Caller ID)**

This feature allows the unit to make a call anonymously.

The default setting is “Off”.

**Important:**

- We recommend setting with your administrator. Contact your administrator for further information.

- 1 **[MENU]** (middle soft key)
- 2 **[▼]/[▲]**: “IP service” → **[SELECT]**
- 3 **[▼]/[▲]**: “Call features” → **[SELECT]**
- 4 **[▼]/[▲]**: “Block Caller ID” → **[SELECT]**
- 5 Proceed with the desired operation.
  - **When 1 line is registered:**  
Go to step 6.
  - **When 2 or more lines are registered:**  
**[▼]/[▲]**: Select the desired line. →  
**[SELECT]**
- 6 **[▼]/[▲]**: Select “on” or “off”. → **[SAVE]**  
→ **[EXIT]**

**Date and time**

Set if the unit does not show the date and time. You can set the date and time through the Web user interface and also program it to adjust automatically using the SNTP. Also daylight saving time setting is available through the Web user interface. Contact your administrator for further information.

- 1 **[MENU]** (middle soft key) → **[#][1][0][1]**
- 2 Enter the current month, date, and year.  
**Example:** March 15, 2010  
**[0][3] [1][5] [1][0]**
- 3 Enter the current hour and minute (12-hour clock format).  
**Example:** 9:30  
**[0][9] [3][0]**
- 4 **[AM/PM]**: Select “AM” or “PM”.
- 5 **[SAVE]** → **[EXIT]**

**Note:**

- When English is selected as the display language, 12-hour clock format is used. When Spanish is selected, 24-hour clock format is used.
- To correct a digit, press **[◀]**, **[▶]**, **[▲]**, or **[▼]** to move the cursor to the digit, then make the correction.

**Updating the base unit software**

Your phone system dealer may offer new features and improve its software version from time to time. If you set the base unit software update setting to manual mode through the Web user interface, you need to download the update when “Update version. Press OK.” is displayed. Contact your administrator for further information.

**Important:**

- Make sure the STATUS indicator on the base unit is lit in green and no line is in use (page 8).
- 1 Press **[OK↵]** while “Update version. Press OK.” is displayed.
    - The current and new base unit software versions are displayed.

- If you want to download the update later, press **[CANCEL]**. When you are ready to download, see “Confirming the base unit software version”, page 39.

## **2 [OK]**

### **Note:**

- The STATUS indicator on the base unit flashes while downloading. When the download is complete, the STATUS indicator stops flashing and changes to steady green.

---

## **Confirming the base unit software version**

### **1 [MENU] (middle soft key) → [≡][1][5][6]**

- The current base unit software version is displayed. To exit, press **[EXIT]**.

### **2** If “**Update version?**” is displayed, press **[OK]** to download. To exit without downloading, press **[CANCEL]**.

---

### Programming through the Web user interface

You can program the following features through the Web user interface. The password is required. Contact your administrator for further information.

- Network settings
- Call forward (page 29, 36)
- Do not disturb (page 30, 37)
- Block anonymous calls (page 30, 37)
- Call block<sup>\*1</sup> (page 30, 37)
- Anonymous calls (Block Caller ID) (page 31, 38)
- Updating the base unit software<sup>\*2</sup> (page 32, 38)

\*1 This feature is explained as “Call Rejection Phone Numbers” in the Web user interface.

\*2 This feature is explained as “Firmware Update” in the Web user interface.

---

### Embedded Web

You need to activate the Web user interface every time you program features using a computer. The Web user interface is deactivated after setting on the computer.

The default setting is “OFF”.

#### Handset

- 1 **[MENU]** (center of joystick) → **[⇄][5][3][4]**
- 2 **[▼]/[▲]**: Select the desired setting.
- 3 **[SAVE]** → **[OFF]**

#### Base unit

- 1 **[MENU]** (middle soft key) → **[⇄][5][3][4]**
- 2 **[▼]/[▲]**: Select the desired setting.
- 3 **[SAVE]** → **[EXIT]**



## Registering a unit

### Operating additional units

#### Additional handsets

Up to 6 handsets can be registered to the base unit.

### Registering a handset to the base unit

The supplied handset and base unit are pre-registered. If for some reason the handset is not registered to the base unit (for example,  $\Psi$  is displayed even when the handset is near the base unit), re-register the handset.

- 1 Handset:**  
[MENU] (center of joystick) → [⇄][1][3][0]
- 2 Base unit:**
  - **KX-TGP500:**  
Press and hold [ALL] for about 4 seconds until the STATUS indicator flashes in red.
  - **KX-TGP550:**  
Press and hold [ALL] for about 4 seconds until the registration tone sounds and the STATUS indicator flashes in red.
    - If all registered handsets start ringing, press the same button to stop. Then repeat from step 1.
    - The next step must be completed within 90 seconds.
- 3 Handset:**  
Press [OK↵], then wait until a long beep sounds.
  - When the handset has been registered successfully,  $\Psi$  will change to  $\Upsilon$ .

#### Note:

- When you purchase an additional handset, refer to the additional handset's installation manual for registration.

### Deregistering a handset

A handset can cancel its own registration (or the registration of another handset) that is stored to the base unit. This allows the handset to end its wireless connection with the system.

#### Handset

- 1** [MENU] (center of joystick) → [⇄][1][3][1]
- 2** [3][3][5] → [OK]
- 3** [▼]/[▲]: Select the desired unit. → [SELECT]
- 4** [▼]/[▲]: "yes" → [SELECT]
  - When you cancel a different handset than the one you are now using, press [OFF] to exit.

#### Base unit

Available for: KX-TGP550

- 1** Press and hold [ALL] until the registration tone sounds and the STATUS indicator flashes in red.
  - If all registered handsets start ringing, press the same button to stop. Then repeat this step.
- 2** Press and hold the handset number ([1] – [6]) that you want to cancel until a confirmation tone sounds.

### Using Caller ID service

Availability of this service depends on your phone system. Contact your administrator for further information.

#### Caller ID features

When an outside call is being received, the caller's information is displayed.

Caller information for the last 100 callers is logged in the caller list from the most recent call to the oldest.

- If the call is received as an anonymous call, "Anonymous call" is displayed.

#### Missed calls

If a call is not answered, the unit treats it as a missed call and "Missed call" is displayed. This lets you know if you should view the caller list to see who called while you were away.

#### Phonebook name display

When caller information is received and it matches a phone number stored in the phonebook, the stored name in the phonebook is displayed and logged in the caller list.

### Ringer ID

This feature can help you identify who is calling by using different ringers for different callers stored in the phonebook (page 20, 23). You can assign a different ringer to each phonebook entry. When a call is received from a caller stored in the phonebook, the assigned ringer rings after the caller information is displayed.

### Caller list

#### Important:

- Make sure the unit's date and time setting is correct (page 31, 38).

#### Viewing the caller list and calling back

##### Handset

- 1 **[CID]** (left soft key)
- 2 Push the joystick down to search from the most recent call, or push the joystick up to search from the oldest call.
  - You can see the detailed information about the caller by pressing **[SINGLE]**.
- 3 To call back, press **[↶]**. To exit, press **[OFF]**.

##### Base unit

**Available for:** KX-TGP550

- 1 **[CID]** (right soft key)
- 2 Press **[▼]** to search from the most recent call, or **[▲]** to search from the oldest call.
  - If an arrow (▶) is displayed after the number, the whole phone number is not shown. Press **[▶]** to see the remaining numbers. To return to the previous display, press **[◀]**.
- 3 To call back, lift the corded handset. To exit, press **[EXIT]**.

#### Note for handset and base unit:

- If the entry has already been viewed or answered, "✓" is displayed, even if it was viewed or answered using another unit.
- In step 3, the unit automatically uses the line the call was received from to call back. If you want to select a line:

**Handset:** **[LINE]** → **[▼]/[▲]**: Select the desired line. → **[↶]**

**Base unit (KX-TGP550):** **[LINE]** → **[▼]/[▲]**: Select the desired line. → Lift the corded handset.

## Editing a caller's phone number before calling back

### Handset

- 1 **[CID]** (left soft key)
- 2 **[▼]/[▲]**: Select the desired entry.
  - You can see the detailed information about the caller by pressing **[SINGLE]**.
- 3 **[MENU]**
- 4 **[▼]/[▲]**: "Edit and Call" → **[SELECT]**
- 5 Edit the number.
  - Press dial key (**[0]** – **[9]**) to add, **[CLEAR]** to delete.
- 6 Press **[CALL]** or **[↶]**.

### Base unit

Available for: KX-TGP550

- 1 **[CID]** (right soft key)
- 2 **[▼]/[▲]**: Select the desired entry.
  - If an arrow (▶) is displayed after the number, the whole phone number is not shown. Press **[▶]** to see the remaining numbers. To return to the previous display, press **[◀]**.
- 3 **[MENU]**
- 4 **[▼]/[▲]**: "Edit and Call" → **[SELECT]**
- 5 Edit the number.
  - Press dial key (**[0]** – **[9]**) to add, **[CLEAR]** to delete.
- 6 Lift the corded handset.

### Note for handset and base unit:

- In step 6, the unit automatically uses the line the call was received from to call back. If you want to select a line:

**Handset:** **[LINE]** → **[▼]/[▲]**: Select the desired line. → Press **[CALL]** or **[↶]**.

**Base unit (KX-TGP550):** **[LINE]** → **[▼]/[▲]**: Select the desired line. → Lift the corded handset.

## Erasing selected caller information

### Handset

- 1 **[CID]** (left soft key)

- 2 **[▼]/[▲]**: Select the desired entry. → **[MENU]**
- 3 **[▼]/[▲]**: "Erase" → **[SELECT]**
- 4 **[▼]/[▲]**: "Yes" → **[SELECT]** → **[OFF]**

### Base unit

Available for: KX-TGP550

- 1 **[CID]** (right soft key)
- 2 **[▼]/[▲]**: Select the desired entry. → **[ERASE]**
- 3 **[▼]/[▲]**: "Yes" → **[SELECT]** → **[EXIT]**

## Erasing all caller information

### Handset

- 1 **[CID]** (left soft key) → **[ERASE]**
- 2 **[▼]/[▲]**: "Yes" → **[SELECT]**

### Base unit

Available for: KX-TGP550

- 1 **[CID]** (right soft key) → **[ERASE]**
- 2 **[▼]/[▲]**: "Yes" → **[SELECT]**

## Storing caller information to the phonebook

### Handset

- 1 **[CID]** (left soft key)
- 2 **[▼]/[▲]**: Select the desired entry.
  - You can see the detailed information about the caller by pressing **[SINGLE]**.
- 3 **[MENU]**
- 4 **[▼]/[▲]**: "Save phonebook" → **[SELECT]**
- 5 Continue from step 3, "Editing entries", page 21.

### Base unit

Available for: KX-TGP550

- 1 **[CID]** (right soft key)
- 2 **[▼]/[▲]**: Select the desired entry.
  - If an arrow (▶) is displayed after the number, the whole phone number is not shown. Press **[▶]** to see the remaining

## Special Features

numbers. To return to the previous display, press [◀].

### 3 [MENU]

### 4 [▼]/[▲]: "Save phonebook" → [SELECT]

### 5 Continue from step 3, "Editing entries", page 24.

## Voice mail service

Voice mail service is available depending on your phone system. Your phone system answers calls for you when you are unavailable to answer the phone or when your line is busy. Messages are recorded by your phone system, not your telephone. Please contact your phone system dealer for details of this service.

### Listening to voice mail messages

The unit lets you know that you have new voice mail messages in the following ways:

- "New Voice Mail" is displayed on the display if message indication service is available.
- The message indicator on the handset flashes slowly if message alert feature is turned on ("Message alert", page 44).
- **KX-TGP550**: The VOICE MAIL indicator on the base unit flashes.

#### Handset

### 1 [MENU] (center of joystick)

### 2 [▼]/[▲]: "New Voice Mail" → [SELECT]

### 3 [▼]/[▲]: Select the desired line. → [SELECT]

-  is displayed next to the line if it has new messages.
- If an arrow (▶) is displayed after the number, the whole phone number is not shown.

Push the joystick right to see the remaining numbers. To return to the previous display, push the joystick left.

### 4 When finished, press [OFF].

#### Base unit

Available for: KX-TGP550

### 1 [VOICE MAIL] → [▼]/[▲]: Select the desired line. → [SELECT]

-  is displayed next to the line if it has new messages.
- If an arrow (▶) is displayed after the number, the whole phone number is not shown.

Press [▶] to see the remaining numbers. To return to the previous display, press [◀].

- Lift the corded handset if needed.

### 2 When finished, press [SP-PHONE] or place the corded handset on the cradle.

## Message alert

You can select whether or not the message indicator on the handset flashes slowly when new voice mail messages are recorded. The default setting is "OFF".

#### Handset

### 1 [MENU] (center of joystick) → [≡][3][4][0]

### 2 [▼]/[▲]: Select the desired setting. → [SAVE] → [OFF]

#### Note:

- While the message alert is on, battery operating time is shortened.

## Intercom features between handsets

### Intercom

Intercom calls can be made between handsets.

#### Note:

- If you receive an outside call while talking on the intercom, you hear interrupt tones (page 28). To answer the call, press **[OFF]**, then press **[↶]**.
- When paging the handset, the paged handset beeps for 1 minute.

### Making an intercom call

- 1 **[MENU]** (center of joystick) → **[▼]/[▲]**: “Intercom” → **[SELECT]**
- 2 **[▼]/[▲]**: Select the desired unit. → **[CALL]**
  - To stop paging, press **[OFF]**.
- 3 When you finish talking, press **[OFF]**.

### Answering an intercom call

- 1 Press **[↶]** to answer the page.
- 2 When you finish talking, press **[OFF]**.

### Auto intercom/Room monitor

This feature allows you to:

- answer an intercom call without pressing any buttons on the handset.
- listen to the sound in a room where the handset is located.

#### Turning auto intercom on/off

“**OFF**” (Default): Turns this feature off.

“**On (Ringer On)**”: When an intercom call is received, the handset rings 2 times then the speakerphone is automatically turned on.

“**On (Ringer Off)**”: When an intercom call is received, the handset does not ring and the speakerphone is automatically turned on. This allows you to easily monitor a baby’s room, for example, from different areas of the house.

- 1 **[MENU]** (center of joystick) → **[#][2][7][3]**
- 2 **[▼]/[▲]**: Select the desired setting.
- 3 **[SAVE]** → **[OFF]**

#### Note:

- Auto intercom cannot be used when:
  - your handset is receiving a transferred outside call.
  - all handsets are being paged by the base unit.

### Answering an intercom call using auto intercom

- 1 When you are paged by another handset, speak into the microphone.
  - To switch to the receiver, press **[↶]**.
- 2 To end the intercom, press **[OFF]**.

### Monitoring audio in a room

You can listen to the sound in a room where another handset is located.

#### Important:

- Before using this feature, set auto intercom on the destination handset to “**On (Ringer Off)**” to allow access by other handsets.
- 1 Call the destination handset (page 45).
    - You can listen to the audio.
  - 2 To mute your sound output, press **[MUTE]** if necessary.
  - 3 Press **[OFF]** to stop monitoring.

### Transferring calls

Outside calls can be transferred between 2 handsets.

- 1 During an outside call, press **[MENU]**.
- 2 **[▼]/[▲]**: “Intercom” → **[SELECT]**
- 3 **[▼]/[▲]**: Select the desired handset. → **[CALL]**
- 4 Wait for the paged party to answer.
  - If the paged party does not answer, press **[↶]** to return to the outside call.
- 5 **[OFF]**

### Transferring a call without speaking to the other handset user

- 1 Perform from step 1 to 3, “Transferring calls”, page 45.
- 2 **[OFF]**
  - The outside call rings at the other handset.

### Note:

- If the other handset user does not answer the call within 1 minute, the call rings at your handset again.

### Answering a transferred call

Press [>] to answer the page.

### Note:

- After the paging party disconnects, you can talk to the outside caller.

---

## Intercom features between the handset and base unit (KX-TGP550 only)

---

### Intercom

Intercom calls can be made between the handset and base unit.





### Note:

- If you receive an outside call while talking on the intercom, you hear interrupt tones (page 28, 34).
  - To answer the call with the handset, press [**OFF**], then press [>].
  - To answer the call with the base unit, place the corded handset on the cradle, then lift it again. If the speakerphone is used, press [**SP-PHONE**] 2 times.
- When paging the handset, the paged handset beeps for 1 minute.



---

### Making an intercom call

#### Handset

- 1 [**MENU**] (center of joystick)
- 2 [>]/[>]: “Intercom” → [**SELECT**]
- 3 [>]/[>]: Select the desired unit. → [**CALL**]
  - To stop paging, press [**OFF**].
- 4 When you finish talking, press [**OFF**].

#### Base unit

- 1 Press [>] – [>] or [**ALL**].
  - Lift the corded handset if needed.
  - To stop paging, press the same button.
- 2 When you finish talking, press [**SP-PHONE**] or place the corded handset on the cradle.

---

### Answering an intercom call

#### Handset

- 1 Press [>] to answer the page.
- 2 When you finish talking, press [**OFF**].

#### Base unit

- 1 Lift the corded handset or press [**SP-PHONE**] to answer the page.
- 2 When you finish talking, place the corded handset on the cradle or press [**SP-PHONE**].

---

### Answering an intercom call using auto intercom

Before using the auto intercom, turn auto intercom on (page 45).

#### Handset

- 1 When you are paged by the base unit, speak into the microphone.
  - To switch to the receiver, press [>].
- 2 To end the intercom, press [**OFF**].

---

### Monitoring audio in a room using auto intercom

You can listen to the sound in a room where the handset is located using the auto intercom.

### Important:

- Before using this feature, set auto intercom on the destination handset to “On (Ringer off)” to allow access by the base unit.

#### Base unit

- 1 Call the destination handset (page 46).
  - You can listen to the audio.
- 2 To mute your sound output, press [**MUTE**] if necessary.
- 3 To stop monitoring, press [**SP-PHONE**] or place the corded handset on the cradle.

## Transferring calls

Outside calls can be transferred between the handset and base unit.

### Handset

- 1 During an outside call, press **[MENU]**.
- 2 **[▼]/[▲]**: “Intercom” → **[SELECT]**
- 3 **[▼]/[▲]**: Select the base unit. → **[CALL]**
- 4 Wait for the paged party to answer.
  - If the paged party does not answer, press **[↶]** to return to the outside call.
- 5 **[OFF]**

### Base unit

- 1 During an outside call, press **[1] – [6]** or **[ALL]**.
- 2 Wait for the paged party to answer.
  - If the paged party does not answer, press the same button as in step 1 to return to the outside call.
- 3 Place the corded handset on the cradle.

## Transferring a call without speaking to the other handset or base unit user

### Handset

- 1 Perform from step 1 to 3, “Transferring calls”, page 47.
- 2 **[OFF]**
  - The outside call rings at the other unit.

### Base unit

- 1 During an outside call, press **[1] – [6]** or **[ALL]**.
- 2 Place the corded handset on the cradle.
  - The outside call rings at the other unit.

### Note for handset and base unit:

- If the other handset or base unit user does not answer the call within 1 minute, the call rings at your unit again.

## Answering a transferred call

### Handset

Press **[↶]** to answer the page.

### Base unit

Lift the corded handset or press **[SP-PHONE]** to answer the page.

### Note for handset and base unit:

- After the paging party disconnects, you can talk to the outside caller.

## Handset locator

You can locate a misplaced handset by paging it.

- 1 **Base unit:**  
**[ALL]**
  - All registered handsets beep for 1 minute.
- 2 To stop paging:  
**Base unit:**  
Press **[ALL]**.  
**Handset:**
  - **KX-TGP500:**  
Press **[OFF]**.
  - **KX-TGP550:**  
Press **[↶]**, then press **[OFF]**.

## Belt clip

■ To attach

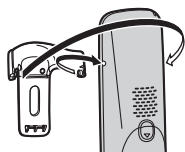

■ To remove



## Wall mounting

### Charger

1 Drive the screws (not supplied) into the wall.

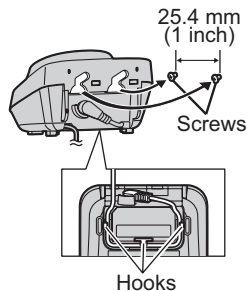

2 Mount the charger (1), then slide it down (2) and to the right (3) until it is secure.

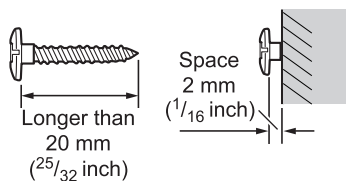
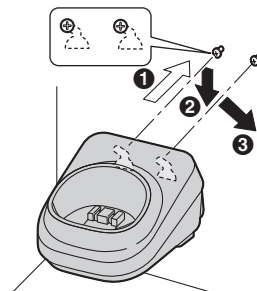

### Note:

- Make sure that the wall is strong enough to support the weight of the unit.



## Base unit (KX-TGP500)

- 1 Remove the base unit stand by pushing (1) and sliding down (2).

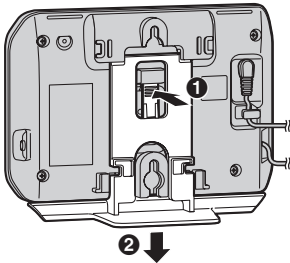

- 2 Mount the base unit by inserting the screws (not supplied) into the round openings on the unit, then slide the unit down to secure it.

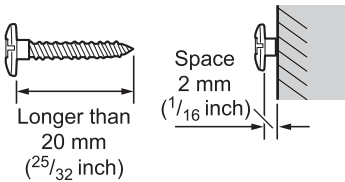
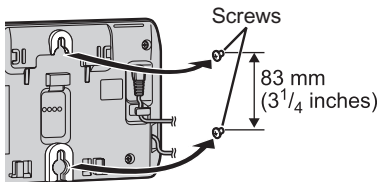

### Note:

- Make sure that the wall is strong enough to support the weight of the unit.

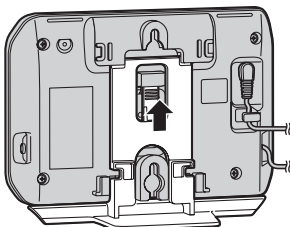

### To attach the base unit stand

Place the base unit stand by fitting the tab into the slot on the base unit. Then slide the stand until it clicks.



## Error messages

If the unit detects a problem, one of the following messages is shown on the display.

| Display message   | Cause/solution  |
|---|---|
| <b>Busy</b>   | <ul style="list-style-type: none"> <li>• The called unit is in use.</li> <li>• The line you tried to join is not set to accept other units (page 14, 18).</li> <li>• 3 lines are already being used. Wait until  changes to  (page 9).</li> <li>• Other units are in use and the system is busy even though  is displayed. Try again later.</li> <li>• The handset you are using is too far from the base unit. Move closer and try again.</li> <li>• The line is in use. You can check the status of the line (page 10).</li> </ul> |
| <b>Error!!</b>  | <ul style="list-style-type: none"> <li>• Other units are in use and the system is busy. Try again later.</li> </ul>   |
| <b>Failed</b>   | <ul style="list-style-type: none"> <li>• Phonebook copy failed (page 25). Confirm the other unit (the receiver) is in standby mode and try again.</li> </ul>  |
| <b>Incomplete</b>                                       | <ul style="list-style-type: none"> <li>• Phonebook copy is incomplete. The receiver's phonebook memory is full. Erase unnecessary phonebook entries (page 21, 24) from the other unit (the receiver) and try again.</li> </ul>  |
| <b>Invalid</b>  | <ul style="list-style-type: none"> <li>• The unit does not have a registered line. Contact your administrator.</li> <li>• The handset you paged from the base unit is not registered (KX-TGP550 only).</li> <li>• If the STATUS indicator still does not light in green, see "STATUS indicator", page 53.</li> </ul>  |
| <b>Memory full</b>                                      | <ul style="list-style-type: none"> <li>• The phonebook memory is full. Erase unnecessary entries (page 21, 24).</li> <li>• The call block list memory is full. Erase unnecessary entries (page 31, 38).</li> </ul>  |
| <b>No link to base. Reconnect main base AC adaptor.</b> | <ul style="list-style-type: none"> <li>• The handset has lost communication with the base unit. Move closer to the base unit and try again.</li> <li>• Unplug the base unit's AC adaptor to reset the unit. Reconnect the adaptor and try again.</li> <li>• The handset's registration may have been canceled. Re-register the handset (page 41).</li> </ul>  |
| <b>Plug Ethernet cable.</b>                             | <ul style="list-style-type: none"> <li>• The supplied Ethernet cable has not been connected yet or not connected properly. Check the connections. Refer to the Quick Guide for details. If the STATUS indicator still does not light in green, see "STATUS indicator", page 53.</li> </ul>  |
| <b>Use rechargeable battery.</b>                        | <ul style="list-style-type: none"> <li>• A wrong type of battery such as Alkaline or Manganese was inserted. Use only the rechargeable Ni-MH batteries noted on page 5.</li> </ul>  |

## Troubleshooting

If you still have difficulties after following the instructions in this section, disconnect the base unit's AC adaptor, then reconnect the base unit's AC adaptor. Remove the batteries from the handset, and then insert the batteries into the handset again.

### General use

| Problem  | Cause/solution   |
|--|--|
| The unit does not work.                                    | <ul style="list-style-type: none"> <li>● Make sure the batteries are installed correctly. Refer to the Quick Guide for details.</li> <li>● Fully charge the batteries. Refer to the Quick Guide for details.</li> <li>● Check the connections. Refer to the Quick Guide for details.</li> <li>● Unplug the base unit's AC adaptor to reset the unit. Reconnect the adaptor and try again.</li> <li>● The handset has not been registered to the base unit. Register the handset (page 41).</li> </ul>  |
| I cannot hear a dial tone.                                 | <ul style="list-style-type: none"> <li>● Confirm the Ethernet cable is properly connected. Refer to the Quick Guide for details.</li> <li>● Network settings may not be correct. Contact your administrator for further information.</li> <li>● Many installation issues can be resolved by resetting all the equipment. First, shut down your modem, router, hub, base unit, and computer. Then turn the devices back on one at a time in this order: modem, router, hub, base unit, computer.</li> <li>● If you cannot access Internet Web pages using your computer, check to see if your phone system is having connection issues in your area. Contact your administrator for further information.</li> </ul> |
| I do not know how to erase "Missed call" from the display. | <ul style="list-style-type: none"> <li>● There are unviewed missed calls remaining. View them and erase the message in the following way.               <p><b>Handset:</b></p> <ol style="list-style-type: none"> <li>1 [CID] (left soft key)</li> <li>2 Push the joystick down to search from the most recent call, or push the joystick up to search from the oldest call.</li> </ol> <p><b>Base unit (KX-TGP550):</b></p> <ol style="list-style-type: none"> <li>1 [CID] (right soft key)</li> <li>2 Press [▼] to search from the most recent call, or press [▲] to search from the oldest call.</li> </ol> </li> </ul>   |
| I cannot remember the password for the Web user interface. | <ul style="list-style-type: none"> <li>● Contact your administrator.</li> </ul>  |

## Useful Information

---

### Programmable settings

---



| Problem  | Cause/solution  |
|--|---|
| I cannot program items.  | <ul style="list-style-type: none"><li>● Programming is not possible while either another handset or the base unit is being used. Try again later.</li><li>● Programming is not possible while the base unit is downloading data. Wait until the STATUS indicator stops flashing and lights in steady green.</li></ul>   |
| The display is in a language I cannot read.  | <ul style="list-style-type: none"><li>● Change the display language (page 10).</li></ul>  |
| While programming, the unit starts to ring.  | <ul style="list-style-type: none"><li>● A call is being received. Answer the call and start again after hanging up.</li></ul>   |
| I cannot register a handset to the base unit.  | <ul style="list-style-type: none"><li>● The maximum number of handsets (6) is already registered to the base unit. Cancel unused handset registrations from the base unit (page 41).</li><li>● Place the handset and the base unit away from other electrical appliances.</li></ul>   |
| I have programmed the Call forward/Do not disturb/Block caller ID/Block anonymous calls, but the unit does not work as programmed. | <ul style="list-style-type: none"><li>● The features may have been programmed by your administrator. Contact your administrator for further information.</li><li>● Features set on your unit may be overridden by your phone system settings.</li><li>● Call forward (“<b>Busy</b>”/“<b>No answer</b>”) does not work when Do not disturb is turned on (page 30, 37).</li></ul> |

## STATUS indicator

| Problem   | Cause/solution  |
|---|---|
| The STATUS indicator continues flashing in amber.                                       | <ul style="list-style-type: none"> <li>● An IP address may not have been acquired or the static IP address is not appropriate. Check the base unit's IP address:<br/><b>Handset:</b><br/><b>[MENU]</b> (center of joystick) → <b>[#][5][0][1]</b><br/><b>Base unit (KX-TGP550 only):</b><br/><b>[MENU]</b> (middle soft key) → <b>[#][5][0][1]</b></li> </ul> <p>We recommend to perform the following with your administrator. Contact your administrator for further information.</p> <ul style="list-style-type: none"> <li>– If necessary, change the base unit's static IP address.</li> <li>– If an IP address was not acquired, check your network devices' (router, modem, etc.) connections. If the connections are made properly but the problem persists, check your network devices' (router, modem, etc.) settings.</li> </ul> <ul style="list-style-type: none"> <li>● Many installation issues can be resolved by resetting all the equipment. First, shut down your modem, router, hub, base unit, and computer. Then turn the devices back on one at a time in this order: modem, router, hub, base unit, computer.</li> <li>● If you cannot access Internet Web pages using your computer, check to see if your phone system is having connection issues in your area.</li> <li>● For more troubleshooting help, contact your administrator.</li> </ul> |
| The STATUS indicator flashes in amber rapidly although the IP address was acquired.     | <ul style="list-style-type: none"> <li>● Unplug the base unit's AC adaptor to reset the unit, then reconnect the AC adaptor. If the STATUS indicator is still flashing in amber rapidly, there may be a problem with the base unit hardware. Contact your phone system dealer.</li> </ul>   |
| The STATUS indicator lights in amber although the Ethernet cable is connected properly. | <ul style="list-style-type: none"> <li>● The base unit's IP address may conflict with the IP addresses of other devices on your local network. Check the base unit's static IP address:<br/><b>Handset:</b><br/><b>[MENU]</b> (center of joystick) → <b>[#][5][0][1]</b><br/><b>Base unit (KX-TGP550 only):</b><br/><b>[MENU]</b> (middle soft key) → <b>[#][5][0][1]</b></li> </ul> <p>Then check the IP addresses of the other devices on your local network. If necessary, change the base unit's static IP address.</p>   |
| The STATUS indicator is off.  | <ul style="list-style-type: none"> <li>● The base unit power is off.</li> <li>● The Ethernet cable is not connected properly. Connect it.</li> <li>● Your network devices (hub, router, etc.) are turned off. Check the LEDs for the link status of the devices.</li> <li>● The base unit power is booting up.</li> </ul>   |

## Useful Information

### Battery recharge

| Problem   | Cause/solution   |
|---|--|
| The handset beeps and/or  flashes.   | <ul style="list-style-type: none"><li>● Battery charge is low. Fully charge the batteries. Refer to the Quick Guide for details.</li></ul>   |
| I fully charged the batteries, but  still flashes or  is displayed. | <ul style="list-style-type: none"><li>● Clean the charge contacts and charge again. Refer to the Quick Guide for details.</li><li>● It is time to replace the batteries. Refer to the Quick Guide for details.</li></ul> |
| I fully charged the batteries, but the operating time seems to be shorter.  | <ul style="list-style-type: none"><li>● Clean the battery ends (<math>\oplus</math>, <math>\ominus</math>) and the charge contacts with a dry cloth and charge again.</li></ul>  |

### Making/answering calls, intercom

| Problem  | Cause/solution  |
|--|---|
|  is displayed. | <ul style="list-style-type: none"><li>● The handset is too far from the base unit. Move closer.</li><li>● The base unit's AC adaptor is not properly connected. Reconnect the AC adaptor to the base unit.</li><li>● You are using the base unit or handset in an area with high electrical interference. Re-position the base unit and use the handset away from sources of interference.</li><li>● The handset is not registered to the base unit. Register it (page 41).</li></ul>                                 |
| Noise is heard, sound cuts in and out.   | <ul style="list-style-type: none"><li>● You are using the handset or base unit in an area with high electrical interference. Re-position the base unit and use the handset away from sources of interference.</li><li>● Move closer to the base unit.</li></ul>   |
| The handset does not ring.   | <ul style="list-style-type: none"><li>● The ringer volume is turned off. Adjust the ringer volume (page 13).</li><li>● Call forward, Do not disturb, or Block anonymous calls may have been programmed by your administrator. Contact your administrator for further information.</li></ul>   |
| The base unit does not ring.* <sup>1</sup>   | <ul style="list-style-type: none"><li>● The ringer volume is turned off. Adjust the ringer volume (page 17).</li><li>● Call forward, Do not disturb, or Block anonymous calls may have been programmed by your administrator. Contact your administrator for further information.</li></ul>   |
| I cannot make a call.  | <ul style="list-style-type: none"><li>● Check if the STATUS indicator is lit in green. If it is not lit in green, see "STATUS indicator", page 8.</li><li>● You cannot make a call while the base unit is downloading the software update. Wait until the STATUS indicator stops flashing and changes to steady green.</li><li>● The handset is too far from the base unit. Move closer and try again.</li><li>● If the problem is not solved after trying the solutions above, contact your administrator.</li></ul> |

| Problem  | Cause/solution   |
|--|--|
| During a conversation, the following occurs: <ul style="list-style-type: none"> <li>– noise is heard.</li> <li>– the sound is interrupted.</li> <li>– the sound is delayed.</li> </ul> | <ul style="list-style-type: none"> <li>● It may be caused by someone using a computer connected to the same network as the unit.</li> <li>● Confirm the speed of Internet connection. The unit requires 100 kbps for each upstream and downstream. If less than 100 kbps is provided, contact your administrator.</li> </ul> |

\*1 KX-TGP550

### Caller ID

| Problem  | Cause/solution   |
|--|--|
| Caller information is not displayed.   | <ul style="list-style-type: none"> <li>● Availability of this service depends on your phone system. Contact your administrator.</li> </ul> |
| The displayed caller information is not correct.   | <ul style="list-style-type: none"> <li>● Caller information may not be correct depending on your phone system.</li> </ul>                  |
| Caller information is displayed late.  | <ul style="list-style-type: none"> <li>● Move closer to the base unit.</li> </ul>  |
| The name stored in the phonebook is not displayed fully while an outside call is being received. | <ul style="list-style-type: none"> <li>● Edit the phonebook entry name to fit in 1 line of text (page 21, 24).</li> </ul>                  |

### Liquid damage

| Problem   | Cause/solution  |
|---|---|
| Liquid or other form of moisture has entered the base unit/handset. | <ul style="list-style-type: none"> <li>● Disconnect the AC adaptor and Ethernet cable from the base unit. Remove the batteries from the handset and leave to dry for at least 3 days. After the base unit/handset are completely dry, reconnect the AC adaptor and Ethernet cable. Insert the batteries and charge fully before use. If the unit does not work properly, contact your phone system dealer.</li> </ul> |

### Caution:

- To avoid permanent damage, do not use a microwave oven to speed up the drying process.

# Specifications

■ **Standard:**

DECT 6.0 (Digital Enhanced Cordless Telecommunications 6.0)

■ **Frequency range:**

1.92 GHz to 1.93 GHz

■ **RF transmission power:**

115 mW (max.)

■ **Power source:**

120 V AC, 60 Hz

■ **Network interface:**

10/100base-TX auto MDI/MDIX Ethernet LAN port

■ **Support codecs:**

G.722, G.711  $\mu$ -law, G.711 A-law, G.726 (32k), G.729A

■ **Power consumption:**

**Base unit:**

**KX-TGP500**

Standby: Approx. 1.3 W

Maximum: Approx. 1.9 W

**KX-TGP550**

Standby: Approx. 2.1 W

Maximum: Approx. 3.6 W

**Charger:**

Standby: Approx. 0.1 W

Maximum: Approx. 2.6 W

■ **Operating conditions:**

0 °C – 40 °C (32 °F – 104 °F), 20 % – 80 % relative air humidity (dry)

**Note:**

- Design and specifications are subject to change without notice.
- The illustrations in these instructions may vary slightly from the actual product.

**Trademarks**

- Microsoft Excel is a registered trademark of Microsoft Corporation in the United States and/or other countries.
- All other trademarks identified herein are the property of their respective owners.



---

---

## Open Source Software

Parts of this product use Open Source Software. Relevant conditions apply to this software. Panasonic cannot accept inquiries regarding the content of the following copyright and license information.

<<NetBSD kernel>>

This product uses a part of NetBSD kernel.

The use of a part of NetBSD kernel is based on the typical BSD style license below.

Copyright (c)

The Regents of the University of California. All rights reserved.

Redistribution and use in source and binary forms, with or without modification, are permitted provided that the following conditions are met:

1. Redistributions of source code must retain the above copyright notice, this list of conditions and the following disclaimer.
2. Redistributions in binary form must reproduce the above copyright notice, this list of conditions and the following disclaimer in the documentation and/or other materials provided with the distribution.
3. All advertising materials mentioning features or use of this software must display the following acknowledgement:  
This product includes software developed by the University of California, Berkeley and its contributors.
4. Neither the name of the University nor the names of its contributors may be used to endorse or promote products derived from this software without specific prior written permission.

THIS SOFTWARE IS PROVIDED BY THE REGENTS AND CONTRIBUTORS "AS IS" AND ANY EXPRESS OR IMPLIED WARRANTIES, INCLUDING, BUT NOT LIMITED TO, THE IMPLIED WARRANTIES OF MERCHANTABILITY AND FITNESS FOR A PARTICULAR PURPOSE ARE DISCLAIMED. IN NO EVENT SHALL THE REGENTS OR CONTRIBUTORS BE LIABLE FOR ANY DIRECT, INDIRECT, INCIDENTAL, SPECIAL, EXEMPLARY, OR CONSEQUENTIAL DAMAGES (INCLUDING, BUT NOT LIMITED TO, PROCUREMENT OF SUBSTITUTE GOODS OR SERVICES; LOSS OF USE, DATA, OR PROFITS; OR BUSINESS INTERRUPTION) HOWEVER CAUSED AND ON ANY THEORY OF LIABILITY, WHETHER IN CONTRACT, STRICT LIABILITY, OR TORT (INCLUDING NEGLIGENCE OR OTHERWISE) ARISING IN ANY WAY OUT OF THE USE OF THIS SOFTWARE, EVEN IF ADVISED OF THE POSSIBILITY OF SUCH DAMAGE.

However, parts of the NetBSD Kernel are provided with the following copyright notices.

- Copyright (c) 1980, 1983, 1988, 1993 The Regents of the University of California. All rights reserved.
- Copyright (c) 1980, 1986, 1989, 1993 The Regents of the University of California. All rights reserved.
- Copyright (c) 1980, 1986, 1991, 1993 The Regents of the University of California. All rights reserved.
- Copyright (c) 1980, 1986, 1993 The Regents of the University of California. All rights reserved.
- Copyright (c) 1982, 1985, 1986, 1988, 1993, 1994 The Regents of the University of California. All rights reserved.
- Copyright (c) 1982, 1986, 1988, 1990, 1993 The Regents of the University of California. All rights reserved.
- Copyright (c) 1982, 1986, 1988, 1990, 1993, 1994, 1995 The Regents of the University of California. All rights reserved.
- Copyright (c) 1982, 1986, 1988, 1990, 1993, 1995 The Regents of the University of California. All rights reserved.
- Copyright (c) 1982, 1986, 1988, 1991, 1993 The Regents of the University of California. All rights reserved.
- Copyright (c) 1982, 1986, 1988, 1993 The Regents of the University of California. All rights reserved.
- Copyright (c) 1982, 1986, 1988, 1993, 1995 The Regents of the University of California. All rights reserved.
- Copyright (c) 1982, 1986, 1989, 1991, 1993 The Regents of the University of California. All rights reserved.
- Copyright (c) 1982, 1986, 1989, 1993 The Regents of the University of California. All rights reserved.
- Copyright (c) 1982, 1986, 1990, 1991, 1993 The Regents of the University of California. All rights reserved.
- Copyright (c) 1982, 1986, 1990, 1993 The Regents of the University of California. All rights reserved.
- Copyright (c) 1982, 1986, 1990, 1993, 1994 The Regents of the University of California. All rights reserved.
- Copyright (c) 1982, 1986, 1991, 1993 The Regents of the University of California. All rights reserved.
- Copyright (c) 1982, 1986, 1991, 1993, 1994 The Regents of the University of California. All rights reserved.

Copyright (c) 1982, 1986, 1991, 1993, 1995 The Regents of the University of California. All rights reserved.  
Copyright (c) 1982, 1986, 1993 The Regents of the University of California. All rights reserved.  
Copyright (c) 1982, 1986, 1993, 1994 The Regents of the University of California. All rights reserved.  
Copyright (c) 1982, 1986, 1993, 1994, 1995 The Regents of the University of California. All rights reserved.  
Copyright (c) 1982, 1986, 1993, 1995 The Regents of the University of California. All rights reserved.  
Copyright (c) 1982, 1988, 1991, 1993 The Regents of the University of California. All rights reserved.  
Copyright (c) 1983, 1990, 1993 The Regents of the University of California. All rights reserved.  
Copyright (c) 1983, 1993 The Regents of the University of California. All rights reserved.  
Copyright (c) 1985, 1986, 1993 The Regents of the University of California. All rights reserved.  
Copyright (c) 1985, 1986, 1993 The Regents of the University of California. All rights reserved.  
Copyright (c) 1986, 1989, 1991, 1993 The Regents of the University of California. All rights reserved.  
Copyright (c) 1986, 1993 The Regents of the University of California. All rights reserved.  
Copyright (c) 1987, 1991, 1993 The Regents of the University of California. All rights reserved.  
Copyright (c) 1987, 1993 The Regents of the University of California. All rights reserved.  
Copyright (c) 1987, 1993 The Regents of the University of California. All rights reserved.  
Copyright (c) 1988 Regents of the University of California. All rights reserved  
Copyright (c) 1988 Stephen Deering.  
Copyright (c) 1988 University of Utah.  
Copyright (c) 1988, 1989, 1993 The Regents of the University of California. All rights reserved.  
Copyright (c) 1988, 1991, 1993 The Regents of the University of California. All rights reserved.  
Copyright (c) 1988, 1992, 1993 The Regents of the University of California. All rights reserved.  
Copyright (c) 1988, 1993 The Regents of the University of California. All rights reserved.  
Copyright (c) 1989 The Regents of the University of California. All rights reserved.  
Copyright (c) 1989, 1991, 1993 The Regents of the University of California. All rights reserved.  
Copyright (c) 1989, 1993 The Regents of the University of California. All rights reserved.  
Copyright (c) 1989, 1993, 1994 The Regents of the University of California. All rights reserved.  
Copyright (c) 1990, 1991, 1993 The Regents of the University of California. All rights reserved.  
Copyright (c) 1990, 1993 The Regents of the University of California. All rights reserved.  
Copyright (c) 1991, 1993 The Regents of the University of California. All rights reserved.  
Copyright (c) 1991, 1993, 1994 The Regents of the University of California. All rights reserved.  
Copyright (c) 1992 Regents of the University of California. All rights reserved.  
Copyright (c) 1992, 1993 The Regents of the University of California. All rights reserved.  
Copyright (c) 1993 The Regents of the University of California. All rights reserved.  
Copyright (c) 1993 Adam Glass  
Copyright (C) 1993 by Sun Microsystems, Inc. All rights reserved.  
Copyright (c) 1994 Gordon W. Ross  
Copyright (c) 1994 Winning Strategies, Inc. All rights reserved.  
Copyright (c) 1995 The Regents of the University of California. All rights reserved.  
Copyright (C) 1995, 1996, 1997, and 1998 WIDE Project. All rights reserved.  
Copyright (c) 1996 The Regents of the University of California. All rights reserved.  
Copyright (c) 1996 John S. Dyson All rights reserved.  
Copyright (c) 1996 Matt Thomas. All rights reserved.  
Copyright (c) 1996 Matthew R. Green. All rights reserved.  
Copyright (c) 1996 Paul Kranenburg  
Copyright (c) 1996, 1997, 1999, 2001 The NetBSD Foundation, Inc. All rights reserved.  
Copyright (c) 1996, 2000 Christopher G. Demetriou. All rights reserved.  
Copyright (c) 1996,1999 by Internet Software Consortium.  
Copyright (c) 1996-1999 by Internet Software Consortium.  
Copyright (c) 1997 Jonathan Stone and Jason R. Thorpe. All rights reserved.  
Copyright (c) 1997 Christos Zoulas. All rights reserved.  
Copyright (c) 1997 Manuel Bouyer. All rights reserved.  
Copyright (c) 1997, 1998 The NetBSD Foundation, Inc. All rights reserved.  
Copyright (c) 1997, 1998, 1999, 2000 The NetBSD Foundation, Inc. All rights reserved.  
Copyright (c) 1997, 1998, 1999, 2001 The NetBSD Foundation, Inc. All rights reserved.  
Copyright (c) 1997, 1998, 1999, 2002 The NetBSD Foundation, Inc. All rights reserved.  
Copyright (c) 1997, 1998, 2000, 2001 The NetBSD Foundation, Inc. All rights reserved.  
Copyright (c) 1997, 1998, 2001 The NetBSD Foundation, Inc. All rights reserved.  
Copyright (c) 1997,98 The NetBSD Foundation, Inc. All rights reserved.  
Copyright (c) 1997-2000 Sony Computer Science Laboratories Inc. All rights reserved.  
Copyright (c) 1997-2002 The NetBSD Foundation, Inc. All rights reserved.  
Copyright (c) 1998 The NetBSD Foundation, Inc. All rights reserved.  
Copyright (c) 1998 Todd C. Miller <Todd.Miller@courtesan.com> All rights reserved.  
Copyright (c) 1998, 1999 The NetBSD Foundation, Inc. All rights reserved.  
Copyright (c) 1998, 1999, 2000 The NetBSD Foundation, Inc. All rights reserved.

Copyright (c) 1998, 1999, 2000, 2001 The NetBSD Foundation, Inc. All rights reserved.  
Copyright (c) 1998, 2000 The NetBSD Foundation, Inc. All rights reserved.  
Copyright (c) 1998, 2000, 2001 The NetBSD Foundation, Inc. All rights reserved.  
Copyright (c) 1999 The NetBSD Foundation, Inc. All rights reserved.  
Copyright (C) 1999 WIDE Project. All rights reserved.  
Copyright (c) 1999, 2000 Jason L. Wright (jason@thought.net) All rights reserved.  
Copyright (c) 1999, 2000 The NetBSD Foundation, Inc. All rights reserved.  
Copyright (c) 1999, 2000, 2001 The NetBSD Foundation, Inc. All rights reserved.  
Copyright (c) 1999, 2001 The NetBSD Foundation, Inc. All rights reserved.  
Copyright (c) 2000 The NetBSD Foundation, Inc. All rights reserved.  
Copyright (c) 2000, 2001 The NetBSD Foundation, Inc. All rights reserved.  
Copyright (c) 2000, 2001, 2002 The NetBSD Foundation, Inc. All rights reserved.  
Copyright (c) 2001 The NetBSD Foundation, Inc. All rights reserved.  
Copyright (c) 2002 The NetBSD Foundation, Inc. All rights reserved.  
Copyright 1998 Massachusetts Institute of Technology. All rights reserved.  
Copyright 2001 Wasabi Systems, Inc. All rights reserved.  
Portions Copyright (c) 1993 by Digital Equipment Corporation.  
Portions Copyright (c) 1995 by International Business Machines, Inc.  
Copyright (c) 1983, 1989 The Regents of the University of California. All rights reserved.  
Copyright (c) 1996 by Internet Software Consortium. All rights reserved.  
Copyright (c) 1980, 1986, 1989 Regents of the University of California. All rights reserved.  
Copyright (c) 1988 The Regents of the University of California. All rights reserved.  
Copyright (c) 1992, 1993 The Regents of the University of California. All rights reserved.  
Copyright (c) 1994 Christopher G. Demetriou. All rights reserved.  
Copyright (c) 1997 The NetBSD Foundation, Inc. All rights reserved.  
Copyright (c) 1999 The NetBSD Foundation, Inc. All rights reserved.  
Copyright (c) 2001 The NetBSD Foundation, Inc. All rights reserved.  
Copyright (c) 1996 Gardner Buchanan <gbuchanan@shl.com> All rights reserved.

Parts of the NetBSD Kernel are provided with the licenses that are slightly different from the above Berkeley-formed license. Please refer the source code of the NetBSD Kernel about the details. The source code of the NetBSD Kernel is provided by the NetBSD CVS Repositories (<http://cvsweb.netbsd.org/bsdweb.cgi/>), and this product includes parts of the source code in the following directories.

<http://cvsweb.netbsd.org/bsdweb.cgi/src/sys/kern/>  
<http://cvsweb.netbsd.org/bsdweb.cgi/src/sys/net/>  
<http://cvsweb.netbsd.org/bsdweb.cgi/src/sys/netinet/>

<<OpenSSL>>

The product includes software developed by the OpenSSL Project and it is used under the following license.

## LICENSE ISSUES =====

The OpenSSL toolkit stays under a dual license, i.e. both the conditions of the OpenSSL License and the original SSLeay license apply to the toolkit. See below for the actual license texts. Actually both licenses are BSD-style Open Source licenses. In case of any license issues related to OpenSSL please contact [openssl-core@openssl.org](mailto:openssl-core@openssl.org).

## OpenSSL License -----

```
/* =====  
* Copyright (c) 1998-2004 The OpenSSL Project. All rights reserved.  
*  
* Redistribution and use in source and binary forms, with or without  
* modification, are permitted provided that the following conditions  
* are met:  
*  
* 1. Redistributions of source code must retain the above copyright  
* notice, this list of conditions and the following disclaimer.  
*  
*/
```

## Open Source Software

---

```
* 2. Redistributions in binary form must reproduce the above copyright
* notice, this list of conditions and the following disclaimer in
* the documentation and/or other materials provided with the
* distribution.
*
* 3. All advertising materials mentioning features or use of this
* software must display the following acknowledgment:
* "This product includes software developed by the OpenSSL Project
* for use in the OpenSSL Toolkit. (http://www.openssl.org/)"
*
* 4. The names "OpenSSL Toolkit" and "OpenSSL Project" must not be used to
* endorse or promote products derived from this software without
* prior written permission. For written permission, please contact
* openssl-core@openssl.org.
*
* 5. Products derived from this software may not be called "OpenSSL"
* nor may "OpenSSL" appear in their names without prior written
* permission of the OpenSSL Project.
*
* 6. Redistributions of any form whatsoever must retain the following
* acknowledgment:
* "This product includes software developed by the OpenSSL Project
* for use in the OpenSSL Toolkit (http://www.openssl.org/)"
*
* THIS SOFTWARE IS PROVIDED BY THE OpenSSL PROJECT ``AS IS'' AND ANY
* EXPRESSED OR IMPLIED WARRANTIES, INCLUDING, BUT NOT LIMITED TO, THE
* IMPLIED WARRANTIES OF MERCHANTABILITY AND FITNESS FOR A PARTICULAR
* PURPOSE ARE DISCLAIMED. IN NO EVENT SHALL THE OpenSSL PROJECT OR
* ITS CONTRIBUTORS BE LIABLE FOR ANY DIRECT, INDIRECT, INCIDENTAL,
* SPECIAL, EXEMPLARY, OR CONSEQUENTIAL DAMAGES (INCLUDING, BUT
* NOT LIMITED TO, PROCUREMENT OF SUBSTITUTE GOODS OR SERVICES;
* LOSS OF USE, DATA, OR PROFITS; OR BUSINESS INTERRUPTION)
* HOWEVER CAUSED AND ON ANY THEORY OF LIABILITY, WHETHER IN CONTRACT,
* STRICT LIABILITY, OR TORT (INCLUDING NEGLIGENCE OR OTHERWISE)
* ARISING IN ANY WAY OUT OF THE USE OF THIS SOFTWARE, EVEN IF ADVISED
* OF THE POSSIBILITY OF SUCH DAMAGE.
* =====
*
* This product includes cryptographic software written by Eric Young
* (eay@cryptsoft.com). This product includes software written by Tim
* Hudson (tjh@cryptsoft.com).
*
*/
```

### Original SSLeay License

---

```
/* Copyright (C) 1995-1998 Eric Young (eay@cryptsoft.com)
* All rights reserved.
*
* This package is an SSL implementation written
* by Eric Young (eay@cryptsoft.com).
* The implementation was written so as to conform with Netscapes SSL.
*
* This library is free for commercial and non-commercial use as long as
* the following conditions are aheared to. The following conditions
* apply to all code found in this distribution, be it the RC4, RSA,
* lhash, DES, etc., code; not just the SSL code. The SSL documentation
* included with this distribution is covered by the same copyright terms
* except that the holder is Tim Hudson (tjh@cryptsoft.com).
*
* Copyright remains Eric Young's, and as such any Copyright notices in
* the code are not to be removed.
* If this package is used in a product, Eric Young should be given attribution
```

\* as the author of the parts of the library used.  
\* This can be in the form of a textual message at program startup or  
\* in documentation (online or textual) provided with the package.  
\*  
\* Redistribution and use in source and binary forms, with or without  
\* modification, are permitted provided that the following conditions  
\* are met:  
\* 1. Redistributions of source code must retain the copyright  
\* notice, this list of conditions and the following disclaimer.  
\* 2. Redistributions in binary form must reproduce the above copyright  
\* notice, this list of conditions and the following disclaimer in the  
\* documentation and/or other materials provided with the distribution.  
\* 3. All advertising materials mentioning features or use of this software  
\* must display the following acknowledgement:  
\* "This product includes cryptographic software written by  
\* Eric Young (eay@cryptsoft.com)"  
\* The word 'cryptographic' can be left out if the rouines from the library  
\* being used are not cryptographic related :-).  
\* 4. If you include any Windows specific code (or a derivative thereof) from  
\* the apps directory (application code) you must include an acknowledgement:  
\* "This product includes software written by Tim Hudson (tjh@cryptsoft.com)"  
\*  
\* THIS SOFTWARE IS PROVIDED BY ERIC YOUNG ``AS IS" AND  
\* ANY EXPRESS OR IMPLIED WARRANTIES, INCLUDING, BUT NOT LIMITED TO, THE  
\* IMPLIED WARRANTIES OF MERCHANTABILITY AND FITNESS FOR A PARTICULAR PURPOSE  
\* ARE DISCLAIMED. IN NO EVENT SHALL THE AUTHOR OR CONTRIBUTORS BE LIABLE  
\* FOR ANY DIRECT, INDIRECT, INCIDENTAL, SPECIAL, EXEMPLARY, OR CONSEQUENTIAL  
\* DAMAGES (INCLUDING, BUT NOT LIMITED TO, PROCUREMENT OF SUBSTITUTE GOODS  
\* OR SERVICES; LOSS OF USE, DATA, OR PROFITS; OR BUSINESS INTERRUPTION)  
\* HOWEVER CAUSED AND ON ANY THEORY OF LIABILITY, WHETHER IN CONTRACT, STRICT  
\* LIABILITY, OR TORT (INCLUDING NEGLIGENCE OR OTHERWISE) ARISING IN ANY WAY  
\* OUT OF THE USE OF THIS SOFTWARE, EVEN IF ADVISED OF THE POSSIBILITY OF  
\* SUCH DAMAGE.  
\*  
\* The licence and distribution terms for any publically available version or  
\* derivative of this code cannot be changed. i.e. this code cannot simply be  
\* copied and put under another distribution licence  
\* [including the GNU Public Licence.]  
\*/

<<MD5>>

This software uses the Source Code of RSA Data Security, Inc. described in the RFC1321 (MD5 Message-Digest Algorithm).

-----  
Copyright (C) 1991-2, RSA Data Security, Inc. Created 1991. All rights reserved.

License to copy and use this software is granted provided that it is identified as the "RSA Data Security, Inc. MD5 Message-Digest Algorithm" in all material mentioning or referencing this software or this function.

License is also granted to make and use derivative works provided that such works are identified as "derived from the RSA Data Security, Inc. MD5 Message-Digest Algorithm" in all material mentioning or referencing the derived work.

RSA Data Security, Inc. makes no representations concerning either the merchantability of this software or the suitability of this software for any particular purpose. It is provided "as is" without express or implied warranty of any kind.

These notices must be retained in any copies of any part of this documentation and/or software.

-----

## Open Source Software

---

<<MT19937>>

The MT19937 software that Takuji Nishimura and Makoto Matsumoto developed is contained, and this product shall be used subject to the following license conditions.

Copyright (C) 1997 - 2002, Makoto Matsumoto and Takuji Nishimura, All rights reserved.

Redistribution and use in source and binary forms, with or without modification, are permitted provided that the following conditions are met:

1. Redistributions of source code must retain the above copyright notice, this list of conditions and the following disclaimer.
2. Redistributions in binary form must reproduce the above copyright notice, this list of conditions and the following disclaimer in the documentation and/or other materials provided with the distribution.
3. The names of its contributors may not be used to endorse or promote products derived from this software without specific prior written permission.

THIS SOFTWARE IS PROVIDED BY THE COPYRIGHT HOLDERS AND CONTRIBUTORS "AS IS" AND ANY EXPRESS OR IMPLIED WARRANTIES, INCLUDING, BUT NOT LIMITED TO, THE IMPLIED WARRANTIES OF MERCHANTABILITY AND FITNESS FOR A PARTICULAR PURPOSE ARE DISCLAIMED. IN NO EVENT SHALL THE COPYRIGHT OWNER OR CONTRIBUTORS BE LIABLE FOR ANY DIRECT, INDIRECT, INCIDENTAL, SPECIAL, EXEMPLARY, OR CONSEQUENTIAL DAMAGES (INCLUDING, BUT NOT LIMITED TO, PROCUREMENT OF SUBSTITUTE GOODS OR SERVICES; LOSS OF USE, DATA, OR PROFITS; OR BUSINESS INTERRUPTION) HOWEVER CAUSED AND ON ANY THEORY OF LIABILITY, WHETHER IN CONTRACT, STRICT LIABILITY, OR TORT (INCLUDING NEGLIGENCE OR OTHERWISE) ARISING IN ANY WAY OUT OF THE USE OF THIS SOFTWARE, EVEN IF ADVISED OF THE POSSIBILITY OF SUCH DAMAGE.

<<thttpd>>

The thttpd software that ACME Labs developed is contained, and this product shall be used subject to the following license conditions.

Copyright 1995,1998,1999,2000 by Jef Poskanzer <jef@acme.com>. All rights reserved.

Redistribution and use in source and binary forms, with or without modification, are permitted provided that the following conditions are met:

1. Redistributions of source code must retain the above copyright notice, this list of conditions and the following disclaimer.
2. Redistributions in binary form must reproduce the above copyright notice, this list of conditions and the following disclaimer in the documentation and/or other materials provided with the distribution.

THIS SOFTWARE IS PROVIDED BY THE AUTHOR AND CONTRIBUTORS ``AS IS" AND ANY EXPRESS OR IMPLIED WARRANTIES, INCLUDING, BUT NOT LIMITED TO, THE IMPLIED WARRANTIES OF MERCHANTABILITY AND FITNESS FOR A PARTICULAR PURPOSE ARE DISCLAIMED. IN NO EVENT SHALL THE AUTHOR OR CONTRIBUTORS BE LIABLE FOR ANY DIRECT, INDIRECT, INCIDENTAL, SPECIAL, EXEMPLARY, OR CONSEQUENTIAL DAMAGES (INCLUDING, BUT NOT LIMITED TO, PROCUREMENT OF SUBSTITUTE GOODS OR SERVICES; LOSS OF USE, DATA, OR PROFITS; OR BUSINESS INTERRUPTION) HOWEVER CAUSED AND ON ANY THEORY OF LIABILITY, WHETHER IN CONTRACT, STRICT LIABILITY, OR TORT (INCLUDING NEGLIGENCE OR OTHERWISE) ARISING IN ANY WAY OUT OF THE USE OF THIS SOFTWARE, EVEN IF ADVISED OF THE POSSIBILITY OF SUCH DAMAGE.

---

---

## Index

- A** Additional handset: 41
  - Anonymous calls: 31, 38
  - Answering calls
    - Base unit: 17
    - Handset: 13
  - Auto intercom: 45
  - Auto talk: 13
- B** Battery: 5
  - Belt clip: 48
  - Block anonymous: 30, 37
  - Block Caller ID: 31, 38
- C** Call block: 30, 37
  - Caller ID service: 42
  - Caller list: 42
  - Caller list edit: 43
  - Call forward: 29, 36
  - Call share: 14, 18
  - Call waiting: 14, 18
  - Chain dial: 21, 24
  - CID (Caller ID): 42
  - Conference calls: 15, 19
- D** Date and time: 31, 38
  - Direct commands: 27, 34
  - Display
    - Contrast: 28, 34
    - Language: 10
  - Do not disturb: 30, 37
- E** Embedded web: 40
  - Emergency calls: 5
  - Error messages: 50
- H** Handset
  - Deregistration: 41
  - Locator: 47
  - Name: 31
  - Registration: 41
  - Hold: 13, 17
- I** Intercom: 45, 46
  - Interrupt tone: 28, 34
  - IP address: 8, 53
  - IP service: 26, 33
  - IP settings: 28, 34
- J** Joining a call: 14, 18
- K** Key tone: 28
- L** Line status: 10
- M** Making calls
  - Base unit: 16
  - Handset: 12
  - Memory full: 50
  - Menu icons: 9, 10
  - Missed calls: 42
  - Mute: 13, 18
- P** Phonebook: 20, 23
- R** Redialing: 12, 16
  - Ringer tone: 28, 34
  - Room monitor: 45, 46
- S** Shared lines: 14, 18
  - Software update: 32, 38
  - Speed dial: 21, 24
  - SP-PHONE (Speakerphone): 16
  - STATUS indicator: 8, 53
- T** Transferring calls: 14, 18, 45, 47
  - Troubleshooting: 51
- V** Voice mail: 44
  - Volume
    - Receiver: 12, 16
    - Ringer (Base unit): 17, 34
    - Ringer (Handset): 13, 28
    - Speaker: 12, 16
- W** Wall mounting: 48
  - Web user interface: 40

**Panasonic Corporation of North America**

One Panasonic Way, Secaucus, New Jersey 07094

**Copyright:**

This material is copyrighted by Panasonic System Networks Co., Ltd., and may be reproduced for internal use only. All other reproduction, in whole or in part, is prohibited without the written consent of Panasonic System Networks Co., Ltd.

© Panasonic System Networks Co., Ltd. 2009